

FEBRUARY, 1974
SOUTHWEST COUNCIL OF SKIN DIVING CLUBS



Membership into this Council

Send the following to :

Mr. Hank Silver, 634 S. Central Expressway, Richardson, Texas 75080

1. Copy of Clubs' constitution and/or Bylaws.
2. Membership list of club including names, addresses, and designated officers.
3. Membership fee (\$10.00 for the club and \$4.00 per individual).

Membership in the Council is from January 1st thru December 31st, at which time dues become due, however, there is a grace period of 3 months, being till March 31st, at which time they expire. Dues may be paid in December of the previous year and will be good for the insuing year if the membership is not used for any council activity before January 1st.

Subscription to the "Southwest Slate"

Subscription is free to members of the council, to non-members is 40¢ per copy or \$3.50 per year. Mail subscriptions to Dick Wilgus, Editor, Southwest Slate, 804 N. High St., Longview, Texas 75601.

Information about the Council

Anyone wishing information about the council, its activities, etc., should send inquiries to the Public Relations Office, Mr. Matt Wiley (Rt. 9, Box 152B, Ft. Worth, Texas 76179) or the President whose address is listed above.

NEWSLETTER

The Southwest Slate is the official voice of the Southwest Council of Diving Clubs and is published monthly. Articles in the "Slate" may be reproduced in full or part (unless otherwise specified) as long as credit is given to the "Slate" and authors of the articles.

"NOTICE"

Articles and pictures for publication in the "Slate" must be in by the 20th of each month as the publication date will be approximately the 1st of each month. Send all material to "Slate", 804 N. High, Longview, Texas 75601.

Dick Wilgus - Managing Editor
 Horst Seeger - Asst. Editor
 Judy Crouch - Staff Writer
 Dee Shappell - Circulation
 Glen Sheridan- Art Editor

STAFF

Larry Henderson Edd Long
 Jack Elliott A. E. Blood
 Dennis Fogarty Weasel Wood
 Earnie Grider Peggy Wilgus

#####

EDITORIAL

Another Convention is now history - I must say, having sat through Conventions for the past 15 years, it was one of the most calm, well-run meetings ever. Mainly due to the leadership we have experienced the past year. We all owe Hank a hardy "Thanks".

I received a considerable amount of compliments as to my work producing the "Slate". I thank all who took the time to acknowledge their appreciation. HOWEVER - I am not solely responsible for our publication. I feel that here is the place to acknowledge those who have helped most graciously! First there is my wife, Peggy, who not only has helped in every way but has also unselfishly allowed me to spend many hours of "her time" working for the Council, for this I am very grateful. Next there are two people who have been most consistent and hard working - Edd Long and Glen Sheridan deserve a great deal of appreciation. To them I say a most deserving "THANK YOU".

There are many more - Cap and Ethyl Blood, Horst Seeger, Mike and Barbara Young, Dennis and Beverly Foggarty, Larry Henderson, Earnie Grider, Jack Elliott and Dee Shappell who has supplied our computer mailing list at no charge to the Council. There are others who have also helped in one way or another by furnishing articles and reports, pictures, labor, ads, etc. To all of the mentioned and unmentioned we are truly grateful; please don't disappoint every one by letting up this year. If I enjoy the same dedication from these people this year as last we should be able to provide another year of regular publications.

Because I have mentioned a number of people don't be misled - we can still use some more help - just get in touch with me if you want to help.

Dick Wilgus

FROM JACK DICK OF THE "SCUBA HUT" SPRINGDALE, ARK., via "DRIFTWOOD"

Jack sends us a code of ethics he teaches to his students. If we all abided by these, divers might have a better reputation.

1. Dive in areas not used by swimmers. (Swimmers cannot relax when a speargun is around).
2. Request permission.
3. CLEAN UP AFTER YOUR DIVE.
4. Give the rod and reel man a break. Stay clear of lines and areas that can be reached by casting. Make a quick entry and stay at a distance.
5. Take only what you need and don't waste fish.
6. Respect boaters - stay clear of public ramps, beaches, etc.
7. Respect other divers...

About the only thing we can add to that is don't show your fish to a frustrated angler. Jack lives by his own code and is a member of several bass clubs. His public relations work with these groups is the reason there is little static about spearfishing on Beaver Lake.

PRESIDENT'S PAGE

Your president is very happy and very humble, in light of my re-election and that of our Council's executive staff. I want to first thank all our Council's members wherever you are for your support this past year. You have made for a year of harmony and this has led to a year of progress. Our activities are becoming well known and our organization is respected by our diving brethren coast to coast.

I believe Dick Wilgus and the voluntary staff of "The Slate" deserve all of our thanks. The dependability and quality of our monthly newsletter is a great example of Progress. Would all of you please write Dick personally and thank him? While you are thinking about Dick and the Slate, go get an ad for the Slate. We have a new program for Dive Shops who advertise and support the Council. Make this promise: get an ad this year. Every club should have an ad....do it folks and our Slate will be bigger, better, and self-supporting!

Shorty Weatherman and the members of Dallas Divers who served on committees for the recently concluded convention are to be congratulated for their magnificent effort which resulted in a highly successful convention. I am personally grateful that so many of you attended in my "home town" and I hope you enjoyed yourselves. For me, it will be a convention to remember the rest of my life. For Shorty, it was a personal triumph because of the time he put in organizing, planning and implementing the varied activities connected with the convention. As I reflect on the Awards Banquet, I wish someone would let me know what went on. I think we all had a super time and the orchestra played great music for dancing, but the entertainment portion of the evening kinda slips my hungover mind. Thanks, Carol.

My congratulations to the winners of the trophies. Each of you earned your award. I encourage all of Council's members to plan to attend the Dives this year and compete as hard as you can. Our thanks to Browning's Trophies. Tom and Geneva put that extra effort into this year's awards. We could all tell because the taste, quality, and engraving were evident.

I am most proud of the beautiful plaque signifying the Service Award. Winning it serving such a fine bunch of people and a fine avocation as diving was easy. You all make it a pleasure to "do the job" and I thank you from the bottom of my heart. I hope and pray that this year will prove as successful for the sake of the Council.

To Wayne Mathewson "Diver of the Year", my heartiest congratulations. You are the perfect choice. The others nominated: Robert Swilly, Cheryl Hubenak, Sandra Matthews, Homer Boxley, also deserve recognition for their diving activities and contributions to the Council. You should know that Wayne has been a strong arm for me and has performed the Council great service. In addition, he dives 100% and is a tough competitor in Spearfishing & Scuba Skill competition.

To all the divers who were awarded 100% pins, I congratulate you. I want to make special mention to recognize the Lawton Divers. Seven of you attended all the dives and most of you attended most all the dives. Your participation is only exceeded by your skill. Four of the top five, Lawton. Seven out of twenty are from Lawton. You Sooners just gotta give us a break!

Our ladies did beautifully this year. Cheryl Hubenak won both Scuba Skill and Spearfishing and if we had a "Lady Diver of the Year" she surely would have won. This year she will win a bigger prize....a new diver for Council membership! Sandra Matthews was a close second to Cheryl last year and promises to be even better during this her second year of competition. Fellas, a mere slip of a girl beat us all at the Scuba Skill events. Have we no shame? Have we no skill? Men of the Council resolve to beat the blond Loreli this year! Cheryl, good luck. We're all out to get you.

President's Page-----2

The Photography Contest was ably put together by Richard Hose. He had a difficult job this year because there were so many entries. He wisely selected three contest judges who were all photographers, and none are members of the Council. The quality of the entries was super. I noticed great talent from some first time entrants which is encouraging. More of you are diving with cameras and your results are splendid. This year each of you should plan to enter the Photo Contest and take your pictures and films with the contest in mind. Read and learn all you can about underwater photography. Not only will you do well in such regional contests as SeaSpace, IDA Festival, and the Council competition, but there are national contests to consider; also your homes will be enhanced with photos of our underwater world.

In closing this rather lengthy piece, let me say I hope you all have a wonderful new year and that you diving is done safely. Plan your Dive. Dive your Plan! I'll see y'all soon.

HANK

1974 Planet Ocean instead of Planet Earth. 3/4ths of the planet is water. Teach the kids to say Planet Ocean

***** **NOTICE** *****

Our new advertising year will begin with the next issue. PLEASE encourage your club and the shop you do business with to support Diving and the Council with an ad of some type.

THANKS



HOME OF THE " OSGAR "

We're represented at

ALL COUNCIL ACTIVITIES

3012 Norman Pl.

Bossier City, Louisiana

71010

Diver's World

Hank & Al now operate a Pro Dive Shop that, in addition to providing the Metroplex quality products, expert, dependable service, and certified Air-Pro-Rated, Travel all over the world, also supports the Council 100% and is strongly in favor of apple pie and motherhood. Now who can fault a shop like that? So shop your SCUBA NEEDS with US. Both you and we will be glad you did.

DIVER'S WORLD, INC.
623 S. CENTRAL EXPRESSWAY
RICHARDSON, TEXAS 75080

on the Dallas, Richardson border, serving the Metroplex.

"HERE IT IS"

Write the Caption
-- CONTEST --

For the person who
submits the most appro-
priate capiton.

\$5.00 CASH PRIZE

If enough interest is
shown we will make
this a monthly con-
test.

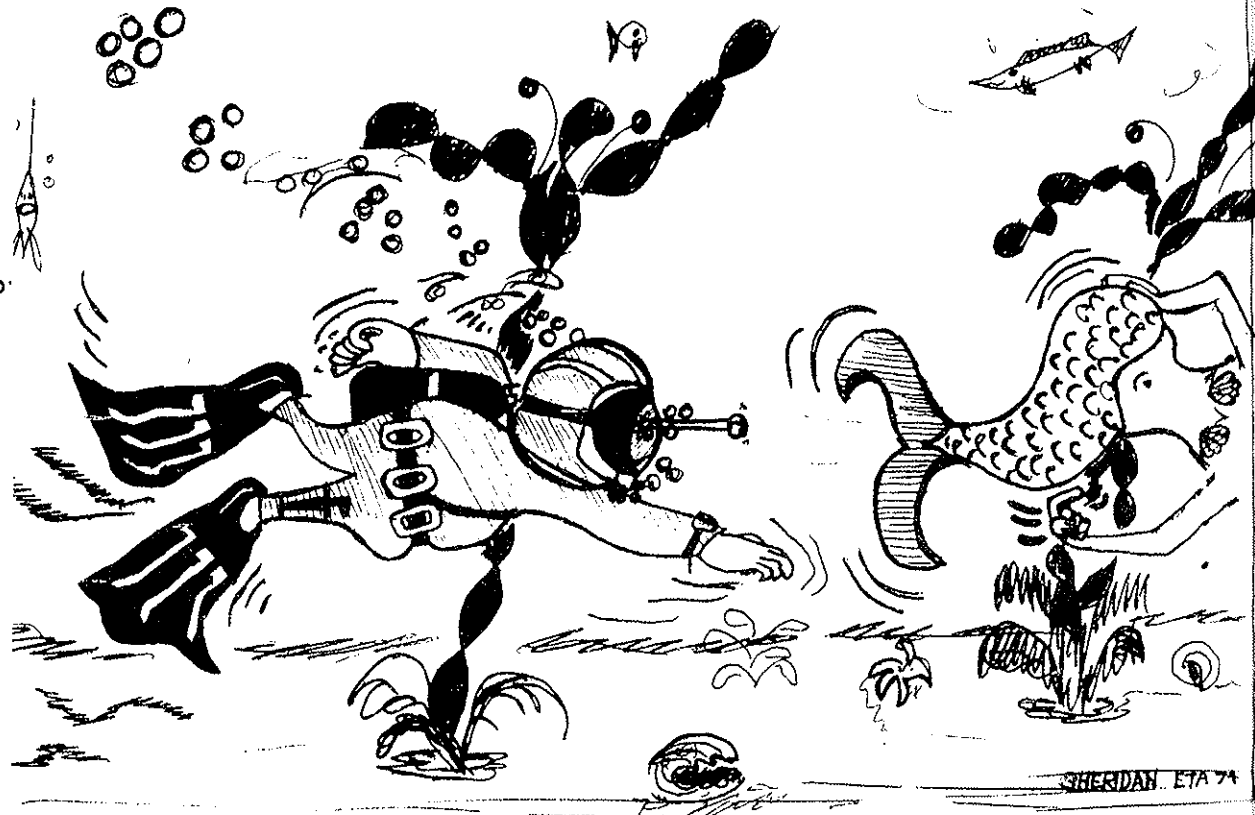

NEWS & VIEWS

We have a new Dive Shop opening in Richardson,
called "Diving World" owned and operated
by Hank Silver and Al Luxum. Watch for their ads.

Exec-VP Wayne Mathewson was chosen "Diver of the
Year" for 1973 --Congratulations, Wayne!

None other than Council President, Hank Silver won
the "Service Award" for '73 and certainly no one
else was more deserving. Don't let up now!

It is being rumored that Edd Long of E.T. Aquanauts
is secretly engaged -- to Glenda Sheridan. At least
they have been seeing a lot of each other.

The family that DIVES together, is unusual.

BAD NEWS

It has been recently announced that there is a ferti-
lizer shortage.

GOOD NEWS

There is not really too much to worry about - this is
an election year.

REMEMBER

The "Slate" Mailing List Will Be Revised
After the March Issue To Include ONLY
The 1975 Council Members.

GET YOUR DUES IN NOW!

NOW !! The Eleventh Edition of the SCIP DIVERS AND INSTRUCTORS MANUAL

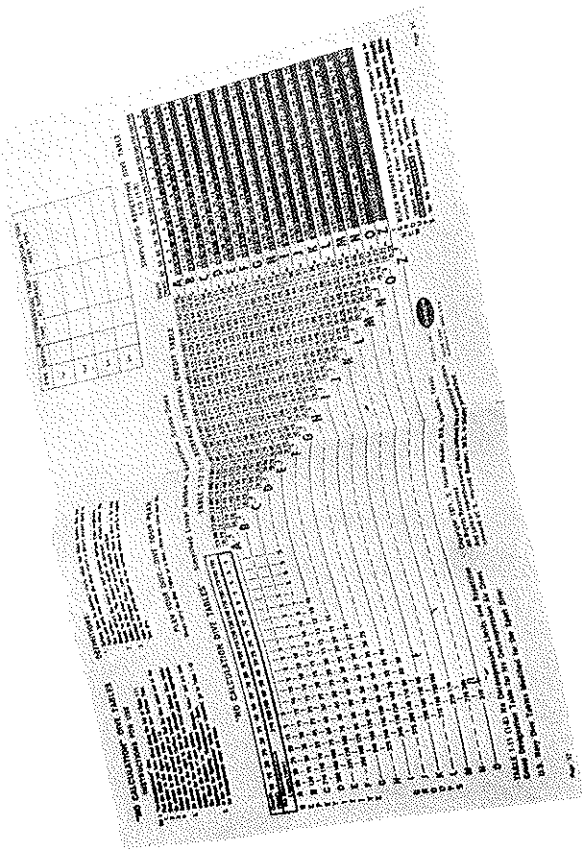

The Reuter "No Calculation Dive Tables" as well as the standard U.S. Navy air decompression tables I-9 through I-14 are featured.

THE SCIP MANUAL IS IN ITS ELEVENTH EDITION, having been first published in 1963. Each succeeding year brought many improvements in the manual both in teaching techniques and technical aspects of diving. This latest edition, as before, reflects the newest in diving training technology, oriented to the beginning sport SCUBA diver.

THE SCIP MANUAL PROGRAM HAS BEEN ACCLAIMED by key leaders in the national certifying agencies. Its recognition is far reaching, finding wide use in NAUI, PADI, NASDS and YMCA classes. You will find the language in keeping with the philosophy of all top underwater instructors.

THE WELL WRITTEN, CONCISE FORMAT CONTRIBUTES to the popular acceptance of the SCIP Manual. The much illustrated material is arranged by subject and is presented clearly and with sufficient depth for ready grasp by the beginning diver. This, we feel, leads to a higher retention of

the point at hand, necessary to the class plan in today's instruction program. It is the intent that the instructor expand on the explanation in his class lecture and in his own style and manner. This freedom should be especially appealing to you.

THE SCIP MANUAL IS DISCOUNTED to shops and instructors for the price of \$2.00 each. Funds generated from their sale will help perpetuate the SCIP scholarship, an aid to students of underwater research. Send for your copies today. The SCIP Manual sales offices are:

TOM HANLEY
14230 EDGECREST
DALLAS, TEXAS 75240

DICK WILGUS
804 NORTH HIGH STREET
LONGVIEW, TEXAS 75601

This brochure is a sample of the paper in the Manual, especially selected for its no-glare qualities and ability of high resolution of print. The manual is printed in the large 8 1/2 x 11 book size.

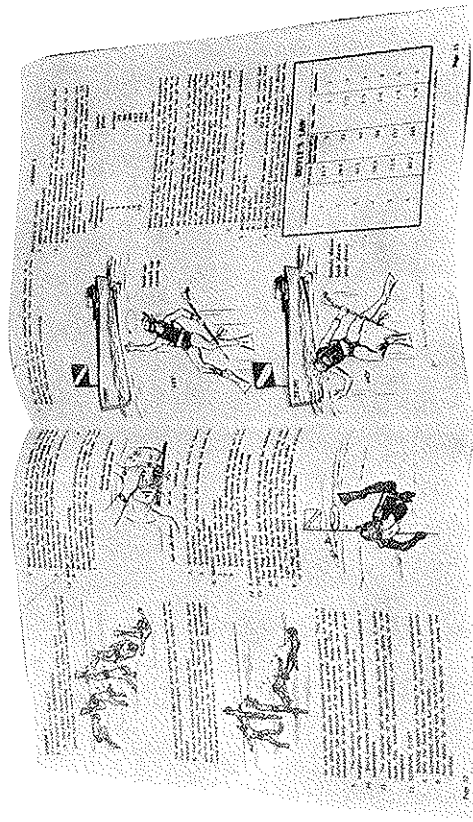

The SCIP Manual is conveniently laid out in lesson form and well illustrated throughout

ALSO AVAILABLE FROM SCIP; three tests for your certified diver class. You can order tests "A", "B" or "C" each with different questions. These tests come with the standard Navy decompression tables and the Reuter tables but without the instructions, for 25c each. You can't duplicate your own for that. Answer keys furnished to the instructor for these tests.

**if you don't have
an OLYMPIC...
your regulator
is out of date**

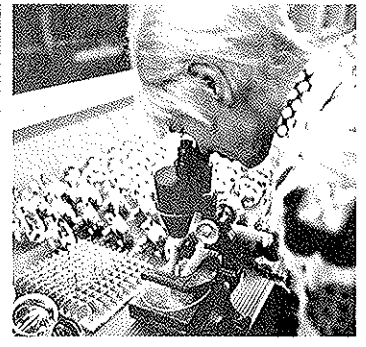
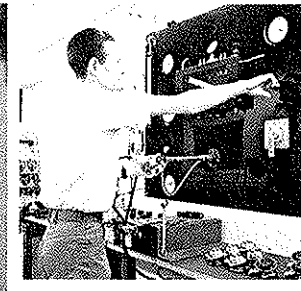
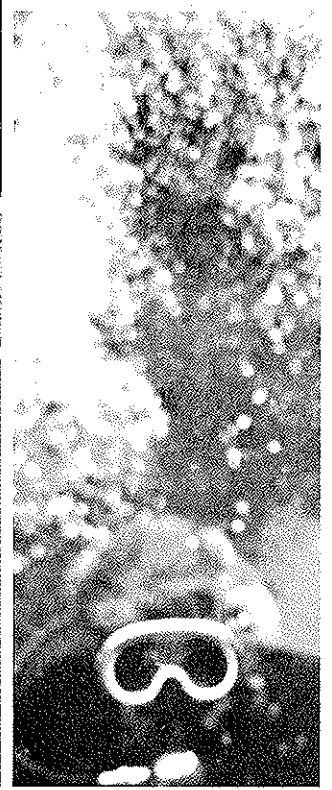
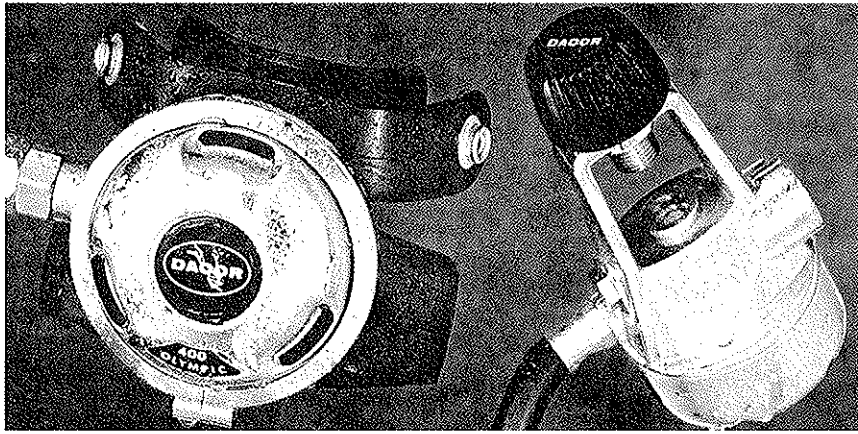
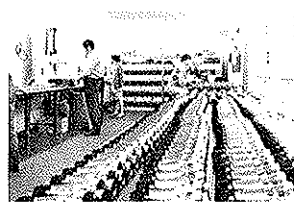

... the company
specializing in imaginative
product development
for human adaptability
underwater.

**Not ordinary
single hose regulators . . .
but sophisticated Breathing Machines
with exclusive features important
to anyone who takes a breath underwater**

**unique Dual Exhaust Valve System
means more exhaust . . . less exhaustion**

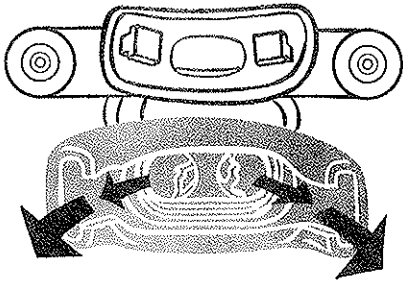

Dacor was the first manufacturer to recognize the importance of exhalation resistance as a major cause of divers' fatigue when we first introduced the Olympic line three years ago and featured our unique Dual Exhaust System (Patent Pending). This revolutionary system has been tested and proven to provide less effort in exhalation than any single exhaust valve system on the market today, regardless of size. In addition to less exhalation resistance, our dual system is 50% easier to purge.

**NEW Anti-Free Flow device with
3 second shut-off (Models 400 and 800)**

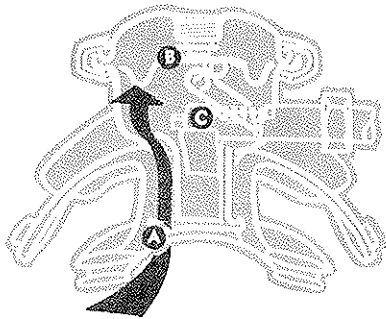

Developed through extensive research by our engineering department, this unique system eliminates free flow when the regulator is removed from the mouth and the second stage is underwater. Free flow occurs in all easy breathing high volume regulators, except the new Olympics with this device.

HERE'S HOW IT WORKS--Free flow is caused by a differential in pressure which opens the second stage valve that allows a steady stream of air to flow from the regulator. Our revolutionary Anti-Free Flow Device prevents this by permitting water to enter the chamber (A) thus raising the diaphragm (B) and shutting off the second stage valve (C). This function is automatic and in actual testing takes a maximum of 3 seconds, thus minimizing wasted air.

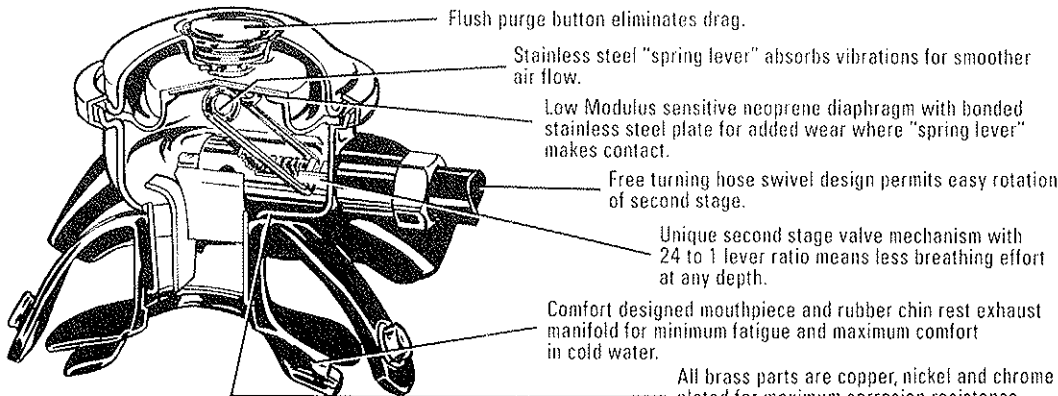

All brass parts are copper, nickel and chrome plated for maximum corrosion resistance.

Balanced First Stage (Models 400 and 800)

Provides absolute minimum breathing effort and maximum air flow, regardless of tank pressure.

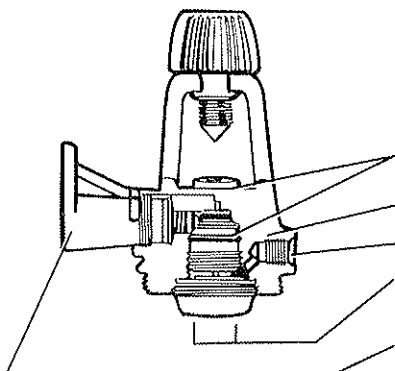

- Dual filtering system traps particles in air down to ten millionths of an inch and prevents these impurities from contaminating the regulator.
- Heavy-duty forging is designed to accommodate higher pressure tank vessels.
- High pressure port for underwater pressure gauge.
- Dual spring for smoother rate, both springs work uniformly to eliminate vibration.
- Modular reserve valve unit is optional on Model 400 and standard on Model 800. Set at 300 P.S.I., has all stainless steel moving parts.



For your 1972 full color catalog and Dacor emblem, send \$1.00 to: Dacor Corporation, 161 Northfield Road, Northfield, Ill. 60093. Phone: (312) 446-9555. Cable: DIVECOR.

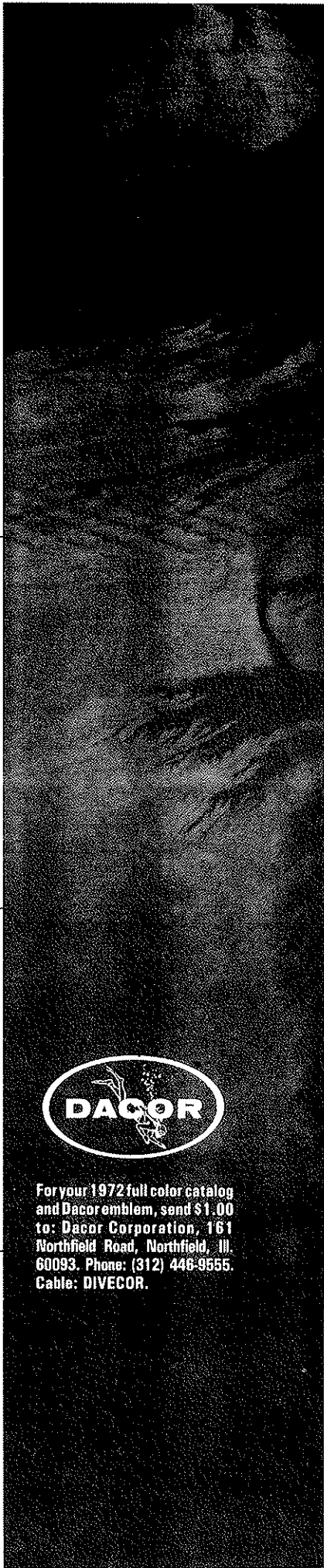

CARIBBEAN PRODUCTIONS presents... R. BROOKS FLEIG'S

SCUBA!

IN COLOR!

...escape to a breathtaking,
true, undersea
experience!

...reach out and
touch another
world!

with **LLOYD BRIDGES** directed by
AMBROSE GAINES III
photography by LAMAR BOREN written by NORMAN WEISSMAN
music by TED ASHFORD • starring KIT FLEIG, BRAD FULLER,
ALICE FLEMING, LEE TURCOTTE, HELEN TURCOTTE

G ALL AGES ADMITTED
GENERAL AUDIENCES

DISTRIBUTED BY GREENSLAND AND GRANT DISTRIBUTIONS, INC.

COMING SOON TO A THEATRE NEAR YOU



Why Group Insurance?

Why has the Underwater Society of America insured all its members? Every diver should know and understand the answer to this question.

There are two basic reasons. Firstly, most obviously and most easily explained, is the motivation to exercise the strength of the whole diving fraternity to ease the great problems and heartache of the family of a fellow member who has met with an unfortunate accident while diving. The second, AND VERY IMPORTANT reason, is to show a doubting world the truth about diving.

What is the truth? It is that diving is a safe, healthy activity, offering the greatest of personal satisfaction and subjecting the prudent diver to no more peril than the safest of popular sports, and much less than many.

Thus we have the reasons:

1. To expose the hoax — the tale of a "dangerous sport".
2. To extend financial help in the rare instance when a prudent diver dies.

Our present carrier, the Continental Casualty Company, a large and prestigious insurance firm who recently proposed dramatic changes in our group accident program, will soon provide added benefits of 24 hour, \$500 accidental death coverage.

The most significant benefit is the new ACCIDENTAL DEATH BENEFIT OF \$2,000

WHILE DIVING. It also provides \$2,000 ACCIDENTAL DISMEMBERMENT COVERAGE WHILE DIVING. The plan is significant because this is the first major insurance carrier to relax the harsh underwriting attitude toward sport divers. Coverage is automatically provided for all members on the effective date of Society membership.

The insurance cost is included in the Society dues structure. If similar coverage were obtained on an individual basis, the cost would be many times that of the annual Society dues.

Many of us are aware of life insurance companies' discriminator practices in the way of ratings and increased premiums because of our activity in the sport. A recent study of the "mortality Rates for Divers" compiled by John McAniff and Hilbert Schenck, Jr. of the Department of Ocean Engineering, University of Rhode Island, indicates to the Society Insurance Director that the extra premiums or ratings in many cases are excessive.

The Underwater Society of America, supported by Continental Casualty's stance and the University of Rhode Island Mortality Report, expects to campaign the issue with the life insurance industry in an attempt to have ratings and extra premiums for sport divers reduced and or eliminated.

A NEW

PRO

DIVE SHOP

Coming To Shreveport Soon

WATCH FOR IT

ZODIAC

First In Inflatables Since 1996

THE DIVER'S BEST FRIEND



ON THE WATER OR UNDER IT, YOU'LL BE GLAD A ZODIAC BROUGHT YOU... THEY'RE FAST, SAFE, DEPENDABLE. NINE EASY-TO-LIVE-WITH MODELS TO CHOOSE FROM. NOW DIVE WHERE YOU WANT TO, NOT WHERE YOU HAVE TO!!

For full details and Zodiac literature write

SILVER

MARINE SALES

634 S. Central Expressway
Richardson, Texas 75080
Phone 231-6561

~~~~~		
X		X
X	1974 DUES ARE DUE NOW	X
X		X
X	CLUB MEMBERSHIP	\$10.00
X	INDIVIDUAL MEMBERSHIP	4.00
X	UNDERWATER SOCIETY	X
X	OF AMERICA (Includes	X
X	Insurance)	3.00
X		X
X	Send all dues to Council Secretary	X
X	Carolyn Weatherman	X
X	1309 Amhurst	X
X	Plano, Texas 75040	X
~~~~~		

SCHEDULE of EVENTS

DATE	SPONSOR	EVENT	LOCATION
Feb. 23-24	YMCA	Advanced Diver Workshop	Jonesboro, Ark. 72401
*March 16-17	LHDM	Contest	P.K.
*April 6-7	IDA	Contest	IDA Pavillon-PK
*May 4-5	Texins	Contest	Travis
*June 8-9	Lawton Divers	Contest	To be Announced
June 15-16	Arkansas Scuba Divers Assoc.	3rd Annual U. S. Freshwater Spear- fishing Championships	Chrystal Spgs. Boat Dock, Lake Ouachita
*June 29-30	Orca Tamers	Contest	To be Announced
*July 20-21	Aqua Jets	Contest	To be Announced
*Dec. 7-8	E.T. Aquanauts	Jim Clark Memorial Gar Rodeo	Curleys Camp Caddo Lake
*Jan 11-12'75	Ark-La-Tex	Gar Rodeo	Bistineau

*Council Sanctioned

WELCOME NEW CLUBS IN THE COUNCIL 1973

Central Texas Diving Clubs	Gabe Sansing, President
Quitman Dolphins	Gary Simpkins, President
Westside Divers	Marshall Sherwin, President

We hope you are all 100% Council members and 100% Council event participants and we hope Council serves your diving appetites with activities throughout the Diving year.

WHEN & WHERE

Traveling divers are sometimes in your town when your club is meeting. There are non-affiliated divers who are seeking information about clubs. If your club welcomes visitors and/or new members----let us know when and where your meetings are held. A new listing will be given each month when you send Slate the information.

DALLAS DIVERS

Second Thursday each month. El Chico Restaurant, North Central Expressway near Richardson, 7:00 P.M.

LES HOMMES DES MER

Second Wednesday. Dallas Aquarium, Fair Park in Dallas, 7:30 P.M.

AMERICAN AIRLINES

Last Monday at Training Building on Lemmon Avenue Parking Lot in Dallas, 7:30 P.M.

INLAND DIVERS ASSOCIATION

Third Thursday each month. Swanky Shack Cafe in Fort Worth, 7:30 P.M.

EAST TEXAS AQUANAUTS

Second Wednesday each month. Tiki Restaurant in Longview, 7:30 P.M.

ARK-LA-TEX DIVERS

First Tuesday each month. 6:30 P.M. Downtown YMCA.

QUITMAN DOLPHINS

Fourth Wednesday each month. Clear Lakes Cafe, 7:30 P.M.

If you would like your club meeting listed, please send info to - Slate, 804 N. High, Longview, Texas 75601.

Without Dive Stores There Would Be No More Diving

A PRO DIVE STORE IS WHERE YOU GET YOUR TANKS REFILLED, REGULATOR REPAIRED, AND SIGN UP FOR NEXT WEEKEND'S DIVE TRIP.

IT'S THE STORE WHICH PROVIDES ALL THE SERVICES NECESSARY FOR DIVING. BUT IN ORDER TO STAY IN BUSINESS AND PROVIDE THOSE SERVICES, HE NEEDS YOUR OTHER BUSINESS ALSO.

SO WHEN YOU'RE THINKING ABOUT BUYING A NEW REGULATOR, NEW WET SUIT, OR ANOTHER SCUBA TANK ... REMEMBER THE STORE WHICH MAKES IT ALL POSSIBLE.

**Get More Out Of
Diving By
Patronizing Your
Local
PRO DIVE STORE**

ADVERTISING RATES 1974 - SOUTHWEST SLATE

Rates are for single copy ads in continuous issues, photo ready. If you wish alternate publications add \$5.00 per month. For non-photo ready ads (we do layout) add \$10.00 for full page - \$5.00 for one half page and \$2.50 for one fourth page. Layout charge is a one time charge for each different layout.

SIZE	1 Issue	3 Issues	4 Issues	6 Issues	12 Issues
Full Page	30.00	85.00	115.00	160.00	300.00
1/2 Page	17.50	45.00	60.00	90.00	160.00
1/4 Page	9.50	25.00	35.00	45.00	80.00
Full Page Insert	12.50				

(You supply printed matter)

Non-Profit Organizations are 1/2 price

PROGRAM CLEARINGHOUSE

Gene Gall - "Gallstone Productions" - 7252 Stefani, Dallas, Texas 75225, 214 - 748-9451
Film Titles ("VA Fogg" "Curacao" "Cozumel" and others)

Hank Silver - "Silverflick Productions" - 634 S. Central, Richardson 75080, 214 - 231-6561 (Dallas)
Film Titles ("Cozumel" "Glover's Reef British Honduras" "Flowergardens and VA Fogg" "Spearfishing under Gulf Rigs" "Cabo San Lucas")

James P. Mularky - 1119 Green Cove, Richardson, Tex. (241-7721)

Slides show of Wreck diving in the Great Lakes
California coast from San Diego to Los Angeles
Cozumel Mexico

(A very experienced diver who also has stories to tell from all over the globe)

Anita Miller - 651 Clearwood Drive, Richardson, Tex. 75080, 214 - 235-2412
80 - 100 slides on Coral Beach Diving on the Barrier Reef at Belize.

Modern Talking Picture Services, Inc., 1411 Slocum St., Dallas, Texas 75207

Judy Crouch, 4718 Maple Ave., Dallas, Texas 75211 (521-9772)

Slides: Cabo San Lucas, Freeport, Grand Bahama Islands, Nassau, Montego Bay, Cozumel

Boyce Petty, 1509 Bella Vista, Dallas, Tex. 75218 (Movie of Jamaica)

Carolyn Weatherman, 1309 Amherst, Plano, Tex. 75074 (Movie of Jamaica)

Anyone else willing to present a program to area clubs, please send name of program to Dick Wilgus, 804 N. High Longview, Texas 75601



- AREA VI REPORT -

Here we are starting on a new year, and I find myself Area V.P. again. I can't see why the clubs in Area 6 would want to put up with me again this year. However, I do appreciate them giving me the opportunity to represent them in the Council's activities again this year.

I would also like to thank the Dallas Divers for a very fine Convention this year. I really enjoyed myself and feel that I express the views of all those attending from Area 6. I was especially glad to see all the delegates from the Aquanauts, Dolphins, and the Ark-La-Tex divers in attendance. I hope that we can keep this interest built up towards the council all year long. At least we are off to a very fine start.

The Ark-La-Tex Divers are very excited about receiving their bid for a sanctioned contest this year. They are already starting to name their committees to plan out all the activities for the contest. We hope to put on one of the best contests ever held in the S.W.C. If the weather holds with us, it just might well be.

I also want to welcome all the members of the Quitman Dolphins into the council. This will be their first year as a club, but I know they will be an asset to the S.W.C. and all of diving as a whole. So come on Dolphins, lets see how many of you can make it to the first contest of the year at Possum Kingdom Lake. That also goes for the divers of the Ark-La-Tex Divers and the Longview Aquanauts. We don't need to lie dormant all summer either.

I guess I have taken up enough space for now, so I will leave you with this thought. You can't really call yourself a diver unless you go diving.

Robert E. Swilley
Area 6 Vice President

AREA 1 REPORT

By the time you read this, the convention will have been over. I know that the Dallas Divers will be relieved once the pressure is off and everything finished. They have put a great deal of effort into this convention to make it the best ever. Many thanks to Shorty Weatherman and his committee - too many to mention. Anita Miller has got some good ideas for entertainment for the upcoming year. Possibly a fashion show? Something about a sneak preview: I think that could be very interesting.

The L.H.D.M. Divers had their annual awards banquet and at the last minute they changed the location. For those of you who were waiting at the Sea Cove to have a good time, the Sizzlers in Garland was already having a good time. The club's top awards went to Ben Sleigh - Diver of the Year; Phillip Rodriguez - Sportsmanship Award; and congratulations to both of you.

The Texins Divers had their annual awards banquet at the Knights of Columbus Hall in Garland. The top awards were given and also several door prizes. Jay Zornes - First Place High Point; Bob Lackey - Second Place High Point; Sam Termine - Third Place High Point; and Wayne Mathewson - Fourth Place High Point. Carolyn Weatherman received First Place High Point for the Women's Division and Kathy Suits received Second Place High Points. Carolyn also received First Largest Fish Award for Women's Division and Bob Lackey received First Largest Fish Award for Men's Division. Ken Snyder received the Outstanding Service Award. All of the trophies were just excellent: thanks to

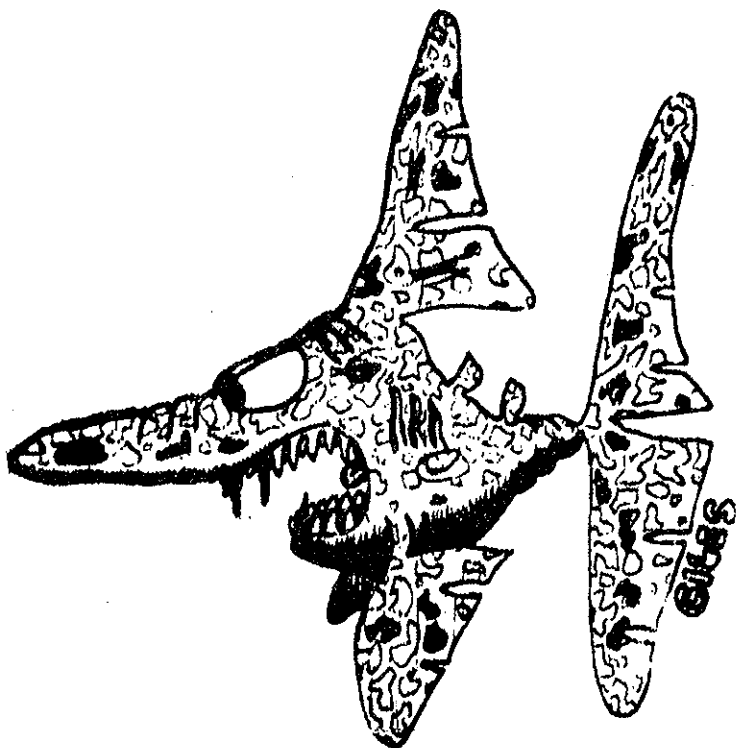

Wayne Mathewson. Congratulations to everyone! The Sanders family walked away with the most door prizes. There were five in their group and they won four bottles of champagne. I expect a full investigation on the matter. You thought Watergate was bad - just wait. Jim, don't erase all of the evidence.

The Sherman divers have had their election of officers and the results are as follows: Tommy Herrin - President; Dewain Groggins - Vice President; Jim Boyd - Sec/Treasurer. Congratulations to the new officers and a fine job done by the outgoing officers. The club is making plans for their annual Ecology dive and several money making projects for the coming year. Several members are planning on attending the convention in February.

I want to thank everyone from all of the clubs in Area 1. I have enjoyed the year very much. I want to especially thank the officers of the clubs for their help in getting the Area 1 report to the slate each month. I know I couldn't have done it alone. I trust that the new officers of each club will be as interested in getting themselves represented in the slate each month as the outgoing officers were. You must remember that the council paper is only as good as everyone wants it to be. I also want to thank the clubs for their generous hospitality in allowing me to sit in on most of their business meetings and give a report on the council activities, both past and future.

Thanks again.

Bob Lackey
Area 1 Vice President

A NEW PRO
DIVE SHOP
COMING TO SHREVEPORT SOON
WATCH FOR GRAND OPENING

