

Oct
1978

THE SLATE

SAFETY
LEGISLATION
CONSERVATION

PHOTOGRAPHY
SCUBA SKILLS
SPEARFISHING



Voice of Southwest Council of Diving Clubs



SWC TREASURER'S REPORT
7-1-78 to 10-10-78

OCTOBER 1978

SLATE STAFF

Managing Editor: Bill Roden
 Asst. Editors: Dennis Fogarty
 Larry Smith
 Edd Long
 Nancy Beard
 Typist: Nancy Beard
 Production Assistants: Beverly Fogarty
 Wade Garvin
 Kenneth Pepper
 Photographer: Jeff Jones
 Editorial Assistant: Clyde Cole

Cash on hand 7-1-78..... \$1,657.13

Income:
 Sanction fee LHDM (March)
 35 spearfishing @ 1.50 (52.50)
 15 scuba skills @ 1.00 (15.00)
 67.50
 Film Festival (DD) 11.00
 Ind. member dues
 11 @ 6.00 66.00
 Slate Ads 89.17
 233.67

Cash available 1,890.80

Disbursements:
 Slate postage
 (E. Saunders) 1.53
 Slate Aug. 91.88
 Sept. 127.52 219.40
 220.93

Cash on hand 10-10-78..... 1,669.87

"Nationals" savings 310.24
 "Disability Fund" 108.91

Myrna Jorgensen
SWC Treasurer



Dear Slate,

Surely hope everyone enjoyed themselves at the contests over the Labor Day weekend. We couldn't make it - but managed to find plenty to get involved in. The Brazos Valley Divers of Waco challenged the Heart of Texas Divers of Temple to an Underwater Monopoly Marathon for Jerry Lewis's kids. Lewis Pack and Travis Garrett of our own Aqua-Holics Divers joined the fun for a few hours. We must give these two clubs a big hand as they played underwater monopoly for 55 straight hours and raised over \$600.00 for Jerry's kids.

Safe diving,

Lewis & Judy Pack
Aqua-Holics Divers



415 WALTER
LONGVIEW, TEXAS 75603

100% SOUTHWEST
COUNCIL MEMBERSHIP



S T A N D I N G S

<u>Position</u>	<u>Name</u>	<u>Club</u>	<u>Points</u>
<u>Men's Division</u>			
1.	Dennis Cocoran	IDA	32
2.	James Permenter	IDA	29
3.	Larry Patterson	IDA	22
4.	Jim Woolridge	IDA	21
5.	Glen Sheridan	AAA	20
6.	Bill Roden	ETA	18
7.	Forrest Garland	ETA	17
8.	Mike Beach	LTV	16
9.	Robert Swilley	Little Gems	16
10.	Wade Garvin	ETA	16
<u>Novice Division</u>			
1.	Bill Roden	ETA	39
2.	Gene Daniel	Lawton	29
3.	Dennis Fogarty	ETA	27
4.	Wade Garvin	ETA	21
5.	Forrest Garland	ETA	17
6.	Bill Reese	Lawton	11
7.	Ray McRight	Lawton	11
8.	Jeff Jones	ETA	10
9.	Ansel Hayes	ETA	10
10.	N. Spence	IDA	8
<u>Women's Division</u>			
1.	Sandra Matthews	IDA	39
2.	Carolyn Embree	AAA	13
3.	Georgia Mayes	Lawton	13
4.	Myrna Jorgensen	Cen-Tex	8
5.	Elizabeth Saunders	ETA	4
6.	Beverly Fogarty	ETA	4
<u>Scuba Skills</u>			
1.	David McMurry	LHDM	28
2.	Susan Stewart	Dallas Divers	22
3.	John Fuller	LHDM	21
4.	Glen Sheridan	AAA	21
5.	Edd Long	ETA	19
6.	Helen Holcomb	Dallas Divers	17
7.	Forrest Garland	ETA	15
8.	Jeff Jones	ETA	14
9.	Sharon Kolesar	Texins	13
10.	Tom Erwin	LHDM	11

AREA I REPORT

LHDM/Texins Challenge Dive

This annual challenge dive between LHDM and the Texins proved to be worth a trip. Even though the waters of Possum Kingdom were still murky from flooding of the Brazos River, everyone enjoyed themselves.

Divers competed in one-buoy and diamond compass runs on Saturday, September 16. This was followed by an evening dinner of hot dogs, chili and fixins with all the beer you could drink. A horseshoe throwing tournament was started but darkness set in before it could be completed.

The spearfishing contest was held on Sunday and was won by the Texins. This was done in spite of the fact that Ben Sleigh of LHDM brought in a 20 lb. buffalo.

Wet Willie WrapUp

The Texins held this annual club event at Lake Travis on the weekend of Sept. 30. The club sponsored an obstacle course, a one-buoy compass run and a spearfishing contest for the clubmembers and visitors. A Saturday evening meal of chili was served by Wayne Mathesin. The weather was beautiful and the water was clear with 15 foot visibility in spots.

Dallas Divers

That Moore presided at the club's September meeting, and Gene Gall showed one of his ever popular movies. This one was on Grand Cayman. A "White Elephant" sale is planned for the October meeting to help build up the Club's treasury.

Jim Mularky brought up a new idea to promote diving. He wants to investigate the possibility of holding a "Dive-In" at one of the Dallas area pools. He proposes that instructors, new dive gear and dive shop displays could be made available

for the general public as well as divers. Those people who have never been in the water could take a carefully supervised dive in the pool, and certified divers could try out new equipment. Sounds like a good idea.

David McMurry
Area I Vice President

AREA IV REPORT

The diving at Amistad has been fantastic this summer. I've been down there almost every weekend since May, and I'm always ready to return. With the flood on the Rio Grande and Pecos last month, it should bring the level back to normal.

It seems like Amistad always has something new to offer in diving. A 25' cabin cruiser was located in 36' of water. For some reason, there are no intentions to raise it. With visibility occasionally in excess of 40', this should be excellent for photography.

Until next month, happy diving.

Bart A. McCollum
Area IV Vice President



CUT OUT FOR ADVENTURE

Are you up tight, so busy making a living that sometimes you forget how to live? If you're like most people, you hardly have time. Too busy meeting deadlines, trying to get it all in before it's all over. Well, it's time you realize this isn't a dress rehearsal. This is your life. Enjoy it now, you only go around once.

LEARN TO SCUBA DIVE AND JOIN THE BEAUTIFUL, SILENT UNDERWATER WORLD.

PHONE 214-787-8112

• Sales • Rentals • Air • Photography • Boat Dive • Advance and Specialty Instruction • Diving Vacations • Charters

Divers Supply Co.

103 E. MELTON, LONGVIEW, TEXAS



AREA V REPORT

It's been a long time. I seem to be gone on business more than I'm home but that is no excuse.

The Cen-Tex Divers are learning! We had a dive at Amistad Labor Day Weekend with a good turnout. Ron and Myrna's boat conked out about 15 miles from camp and they were cooked when they finally limped in four hours later. Marty Vonderheid dropped his speargun in 130 feet of water and decided it wasn't worth it (without a wetsuit) to go get it. Jon Kangas recovered Mike Choates girlfriend's rod and reel in 20 feet and she repaid that by catching a 2 lb. bass on it.

Texins invited us to participate in their Wet Willie WrapUp held at Lake Travis the end of Sept. and we showed them we are going to give them some competition. Chuck Bradley (pres.) came in first with 7½" on the compass run and Marty Vonderheid came in third with 24". The obstacle course was bombed with Marty and Chuck both getting tangled in the ropes. In the spearfishing event Bill Prout came in first in novice and second in largest fish with a 15½ lb. buffalo. You all look out, the Cen-Tex Divers are on the move! They are holding a scuba skills and spearfishing seminar at Lake Travis October 15.

If anyone is down this way, our meetings are held - 1st Thursday each month, 7:00 p.m., Sirloin Stockade on Highway 183 across from K-Mart.

See you in the Slate next month.
DON'T WAIT....COMMUNICATE.

Ron Jorgensen
Area V Vice President

AREA VI REPORT

Lawton's Lake Murray dive was great, the weather, the water and the meal served by Lawton Divers. The Aquanauts just couldn't find any fish, but the Aquanauts weren't the only ones. Aquanaut Edd Long did well in scuba skills.

Being an old member of ETA, I know the Aquanauts are busy with the annual club raffle and plans for the Gar Rodeo. But I didn't get to attend the October ETA meeting, so if there is anything else the Aquanauts want in this report, it will be added by ETA Public Relations Officer Jeff Jones.

Dennis Fogarty
Area VI Vice President

AREA VI ADDENDUM

In addition to Dennis Fogarty's report, during the October meeting of the East Texas Aquanauts, two new members were voted into the club. Keith Meier and Clifford Barnes are both certified divers, and intend to work for the ETA and promote safe diving whenever possible.

The ETA officers are presently working on a bid for the SWC Annual Convention. In order to conserve time, the club voted in favor of the officers working up and submitting a bid for the convention without any further action required by the club membership. The bid should be submitted to the SWC sometime within the next two to three weeks.

Jeff Jones
Public Relations Officer, ETA

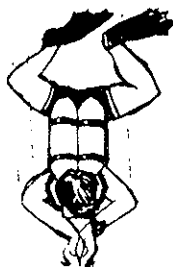

ALL NEW DACOR PACER™*

*POSITIVE AIR CONTROLLED EQUALIZING REGULATOR™

PATENTS PENDING

Highly sensitive neoprene diaphragm with bonded stainless steel plate for added wear at contact point with demand lever activator.

Stainless steel demand lever activator provides a 24 to 1 lever ratio for smooth, effortless delivery.

All brass parts are copper, nickel and chrome plated for maximum corrosion resistance.

Free turning hose swivel permits easy rotation.

Dual Exhaust System for easier exhalation and purging. (See facing page (C))

Optional extreme condition kit available.

Anti-Free Flow Device with special water chamber. (See facing page (D))

Venturamatic Flow Vane™ and Venturamatic Booster Clip™ disperse and deflect flow to "air" balance second stage. (See facing page (A), (B))

Orthodontic designed contoured mouthpiece provides maximum comfort with minimum fatigue.

PACER Model 900

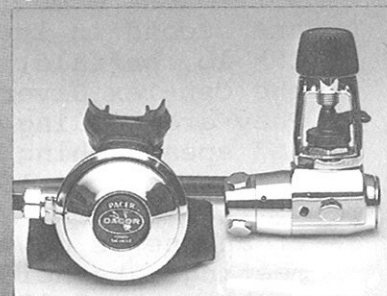
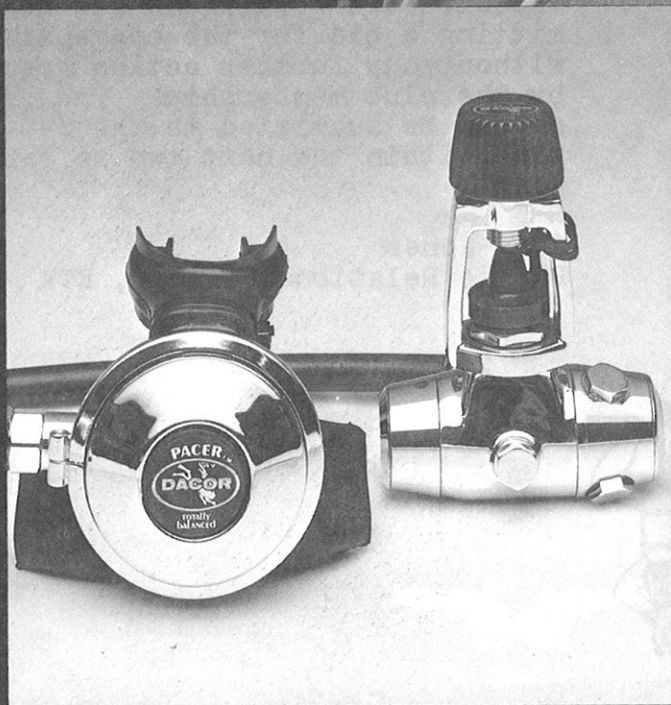

PACER Model 600

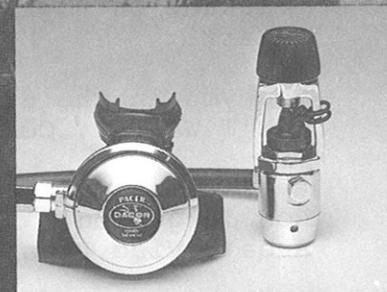

PACER Model 300

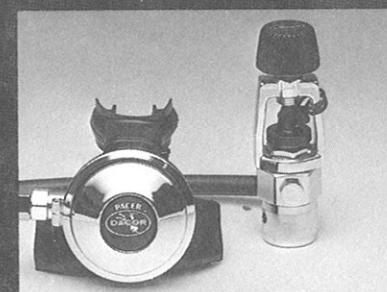

PACER Model 150

**A
WHOLE NEW
GENERATION
OF REGULATORS
THAT INCREASE
YOUR COMFORT,
CONFIDENCE,
AND
DIVE TIME.**



THE DALLAS DIVERS IN CONJUNCTION WITH THE METROPLEX DIVE SHOPS INVITE YOU TO ATTEND THE FIRST ANNUAL DIVE-IN. NOW IS YOUR CHANCE TO TRY ALL THE LATEST EQUIPMENT IN THE BEAUTIFUL TRIPLE SIZE, 18-FOOT DEEP LOOS POOLS. SEVEN DIVE SHOPS WILL BE THERE WITH THE LATEST EQUIPMENT. THE EQUIPMENT LIST IS NOT COMPLETE, BUT THE DIVE SHOPS ATTENDING HAVE COMMITTED TO EQUIPMENT FROM SWIMMASTER, POSIEDON, U.S. DIVERS, DACOR, WHITE STAG, FARALLON, SEATEC, FENZY, SCUBAPRO, BOTTOM TIMER, AND MORE. THE LATEST IN REGULATORS AND BUOYANCY SYSTEMS WILL BE THERE. YES, THE ONES YOU HAVE BEEN READING ABOUT IN "SKIN DIVER".

THE DIVE-IN WILL BE HELD NOVEMBER 25 FROM 1:00 PM UNTIL 5:00 PM. LOOS POOL IS LOCATED NORTH OF THE L.B.J. FREEWAY ON MARSH LANE AT SPRING VALLEY.

YOU MUST BRING YOUR C CARD, SWIMSUIT, MASK, FINS, AND SNORKEL. DON'T FORGET A TOWEL. ADMISSION IS \$2.50. DO NOT BRING ANY TANKS OR REGULATORS.

IF YOU NEED MORE INFORMATION, CONTACT YOUR METROPLEX DIVE SHOP OR CALL
JIM MULARKEY -- HOME: 214-235-4918
BUS: 214-654-5055

JIM MULARKEY
DALLAS DIVERS VICE PRESIDENT



THINK DEEP



LET'S GO

DIVING!

SILVER STREAK DIVE TOURS

scuba

PRESENTS DIVING

LIGHTHOUSE REEF

and

THE GREAT BLUE HOLE



DIVE WITH US THE "SUNKEN CLOISTER" AS COUSTEAU CALLS IT. DIVE THE MOST BEAUTIFUL REEFS AND DROP-OFFS IN BELIZE. THIS IS DIVING AT ITS BEST. OPEN TO EXPERIENCED DIVERS. WE CAN TAKE ONLY 20 AT ONE TIME, MAKE YOUR RESERVATION NOW WITH A \$100. DEPOSIT. DON'T BE DISAPOINTED.

**DEC 27 TO
JAN 3
\$ 575**

"THE FINEST DIVING IN THE WESTERN HEMISPHERE"

SPACE IS LIMITED

Divers Supply Co.

103 E. MELTON, LONGVIEW, TEXAS

PHONE 214 - 757-6112

SALES - RENTAL - AIR - REPAIR

photograph

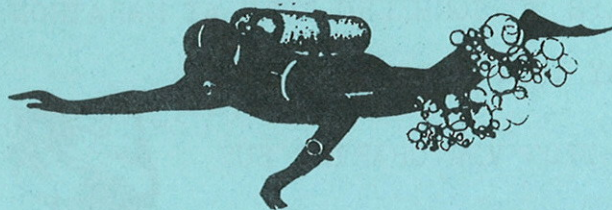

DEPOSIT OF ~~400~~ DUE **NOW!**

CONTACT DIVERS SUPPLY FOR MORE INFORMATION AND DETAILS. PRIVATE MOVIE SHOWING OF THIS TRIP AVAILABLE TO GROUPS OF 4 OR MORE ON REQUEST

DIVERS SUPPLY CO.

AIR*SALES*RENTAL*REPAIR*TANK CLEANING & TESTING

-COMMERCIAL DIVING-



103 E. Melton St.
Longview, Texas 75601
AC 214/757-6112



Travel Section



TRAVELING IN THE LUXURY OF
A 40 PASSENGER COACH COMPLETE
WITH SLEEPING ACCOMODATIONS
FOR EACH PASSENGER, AIRCON-
DITIONED AND REST ROOM FACILITIES.

Wondering
where to
dive?

THANKSGIVING TRIP TO FLORIDA KEYS \$195 NOVEMBER 23 RD THRU 26 TH

PRICE INCLUDES

- *TWO FULL DAYS DIVING IN CLEAR , 100 ft. VISIBILITY FLORIDA SPRINGS
- *TWO HALF DAY REEF TRIPS TO SOMBRERO REEF AT MARATHON KEY (CORAL LAGOON)
- *HOTEL ROOMS AT HOLIDAY INN, MARATHON KEY
- *ROUND TRIP TRANSPORTATION VIA CHARTER BUS



Divers Supply Co.

103 E. MELTON, LONGVIEW, TEXAS
PHONE 214 - 757-6112
SALES - RENTAL - AIR - REPAIR

**SPACE
IS
LIMITED**

NOTE: A DEPOSIT OF \$25.00
MUST BE PAID ON OR BEFORE
NOVEMBER 18th
TO INSURE A PLACE ON BUS -
BALANCE ON OR BEFORE DEPARTURE.

**Diving Is Our Business
Not A Sideline**

Scubapro - Dacor - Subsea - Imperial - Ikelite - Sekonic - Nikonos - Seatec
Farallon - Nemrod - Sportsways - Aqua Craft - Global - White Stag
Oceanics - U. S. Divers - Swimaster - Healthways

SCUBAPRO SWEEPSTAKES

Everyone Who Enters The Scubapro Christmas Sweepstakes Is A Winner

1

FIRST PRIZE

A Datsun Lil Hustler

WIN your own set of scuba wheels. This economical Datsun Lil Hustler pick-up truck will take you to your favorite water hole in scuba style.

2

SECOND PRIZE

An all expense paid trip for two to Anthony's Key Resort

3

AND

4

THIRD AND FOURTH PRIZES

A Tad Kayak

The Tad 4.2 meter Offshore Kayak gives you a simple new way to go down to those previously hard to get to places. Sporting a safe open cockpit design, positive flotation, moulded diving tank well and 6 cubic feet of water free storage, the Tad is light (45 lbs.) and durable (3 layers of hand laid fiberglass). It's new, it's exciting, it's simple and it works!

IMPORTANT NOTE: No purchase necessary. Enter as often as you like, but each entry must be accompanied by an official entry blank or your name and address clearly hand-printed on a blank 3x5 card. Scubapro 3105 E. Harcourt, Compton, CA 90221.



HOW TO ENTER

Simply visit your local participating Scubapro dealer and ask for a Scubapro Christmas Sweepstakes Entry Form, then deposit your entry in the Scubapro Display. Drawings will be held in January, 1979 at the DEMA Show. One entry per dealer visit. Deadline for entries is December 24, 1978. Void wherever prohibited or restricted by law. Scubapro employees or their agents are not eligible. Available only at participating Scubapro dealers.

EVERYBODY WINS
Get your
Free Floating
Key Chain



available only
at participating
Scubapro
Dealers.



Seven nights and six days of diving the sparkling clear waters off the island of Roatan, Honduras. Includes airfare, hotel, meals, dive boat, gear rental, air and a variety of sideline activities.

TAN airlines **SAHSA** airlines

Join the celebration. Gift a diver for Christmas with Scubapro.

GAUGES



When you want to operate better under pressure, Scubapro gauges point you in the right direction. Find your way with our panel of experts the Scubapro Instrument Console, and know where you air at all times with a Scubapro Submersible Tank Pressure Gauge.

Fancy that! Scubapro fashions are in for the serious diver. Lightweight wind breakers with snappy graphics. Sharp looking swimwear. All weather jackets. In men's and women's sizes.

The most finely tuned underwater instruments to ever draw a breath are Scubapro regulators. The Mark VII with your built-in "diving buddy" audio reserve. The Balanced Mark V where easy breathing had its turning point. And old reliable Mark III. Mark V and Mark VII are all now available with the revolutionary Pilot second stage.

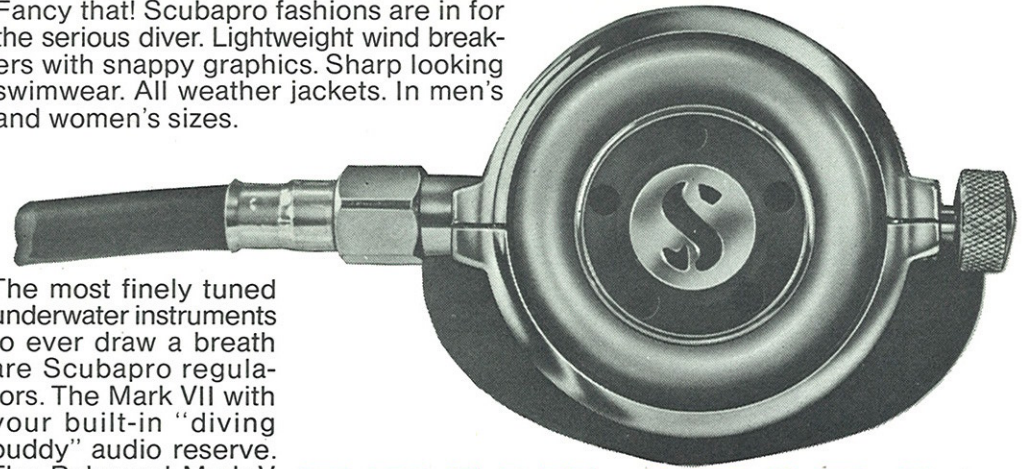

REGULATORS

Copyright Scubapro 1978

FINS

Just what everyone needs—a good, swift kick. That's Scubapro Jet Fins, the diver's symbol of speed and power. Sized for men and women.

Snorkels Every diver could always use another snorkel. Like one of the Jet Snorkels—the Wrap-Around, Off-Set or Swivel Tip. Choose from eight different styles for every kind of water fun activity.

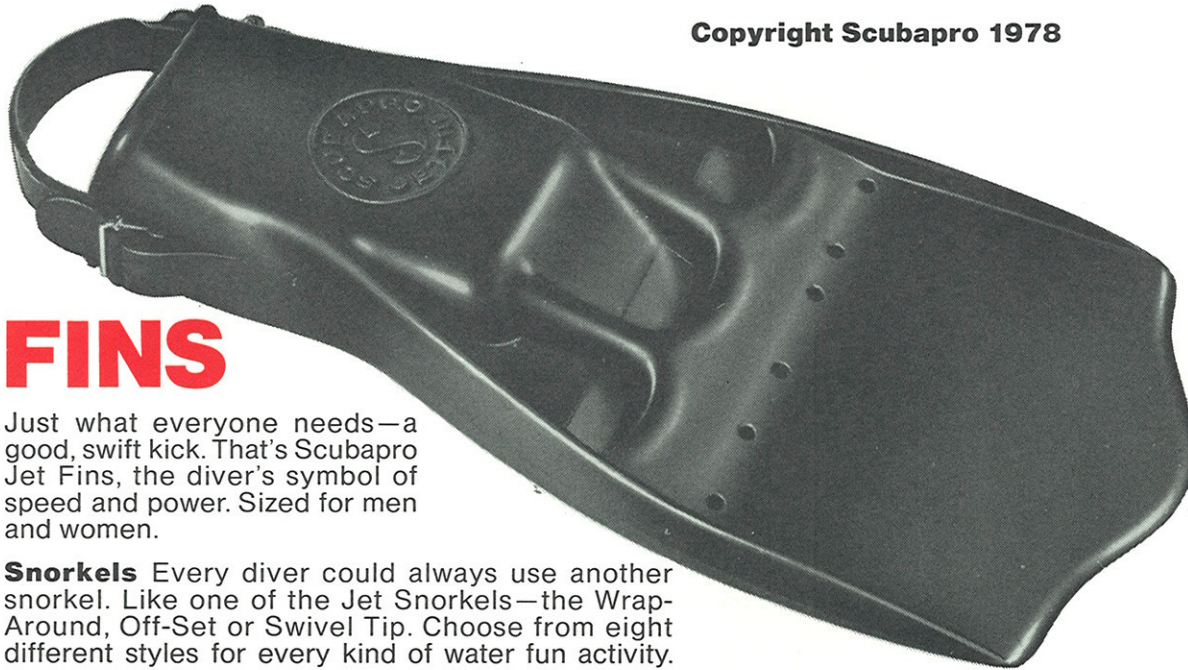

SNORKELS

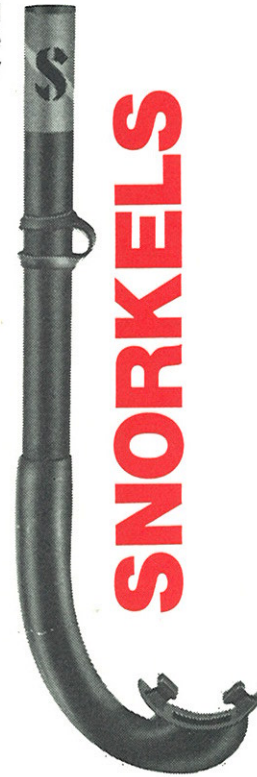

As a gift you couldn't ask for better timing. Above and below the water, a Scubapro Divers' Watch tells great diving time.

WATCHES

GIFT A DIVER FOR CHRISTMAS

CLASSIC GIFTS FOR THE SERIOUS DIVER

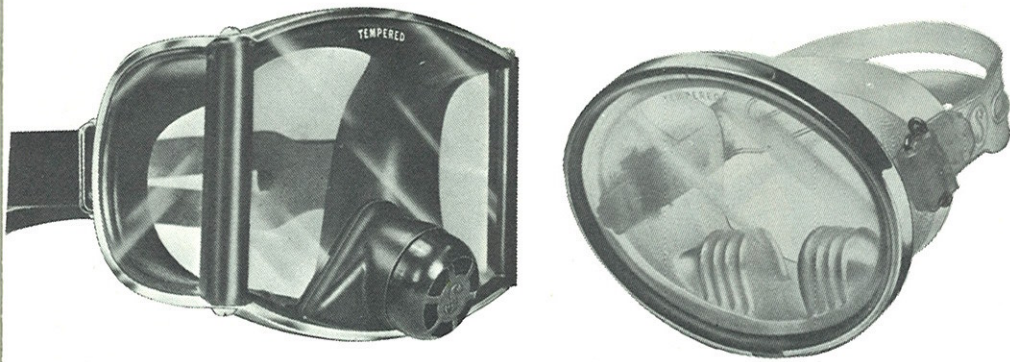

MASKS

How to see beneath the sea regardless of what shape your face is in. Your choice of narrow, wide, wider or widest . . . from Supervision to Free Vision. Clear up the air with anti-allergy H/T mask. Or just settle for the best in traditional ovals. But remember, good looks won't go unseen when you wear a pro mask by Scubapro.



SCUBAPRO OPTICAL MASK

Clearly a better way to see where you're diving. If you've got an eye for a good thing say eye to optics. Precise optical lens brings things into focus. Available in 1/2" diopter increments from 1-10. Great for seeing on the surface too.

FASHIONS



Gift Certificates The ultimate Christmas gift. Turn someone on to the fun and excitement of the underwater world. Give a gift certificate for a complete professionally taught course in scuba diving. It's a gift that will last a lifetime.



GIFT CERTIFICATE FOR SCUBA LESSONS

This certificate entitles the bearer to attend and complete a professionally instructed course at the following Scubapro Educational Association (SEA) Member:



Student _____ Sponsor _____



PROFLEX SUIT

Give someone a fish and you feed him for a day. Teach someone to fish and you feed him for a lifetime.

SPEAR FISHING

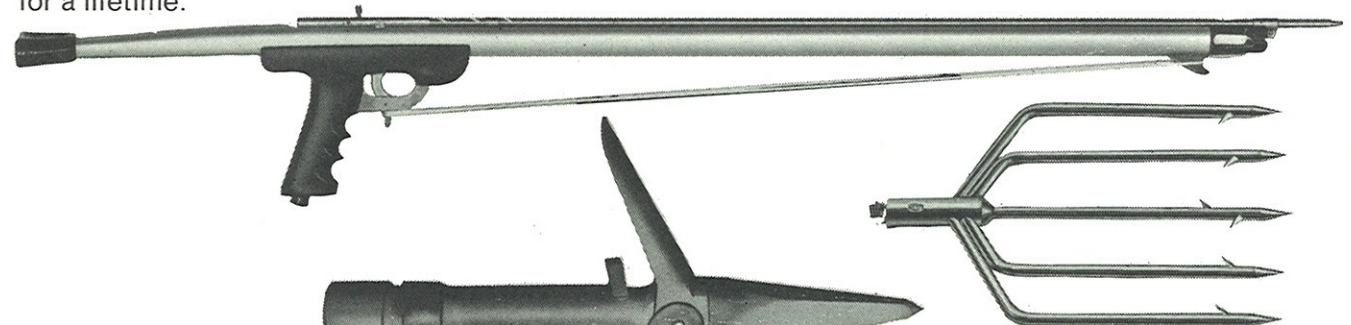

Beat the cold with Scubaproflex the re-invented wet suit that is soft, silky, strong, durable and stretches like crazy. Scubaproflex slides over any body, stretching over the humps and bumps, filling in all the curves and angles. It's a breeze to don and doff and its special snug fit holds in the heat while keeping out the cold. Available in men's and women's styles and sizes.

KNIVES

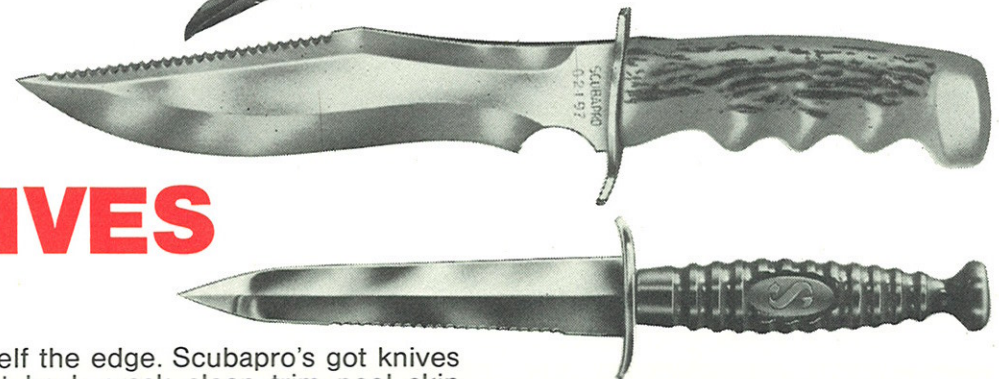

Give yourself the edge. Scubapro's got knives that cut, gut, hack, crack, clean, trim, peel, skin



SCUBAPRO



**Enter The
Scubapro
Christmas
Sweepstakes**

that cut, get, mask, and... and file nice enough not to ruin a good catch.

SNORKELING

The first step to fun and adventure. Gives you a fish-eye view of the marvels underwater. Snorkel and mask kit are great for pool or beach. Snorkeling outfit with mask, fins, snorkel and vest are perfect for vacation trips.

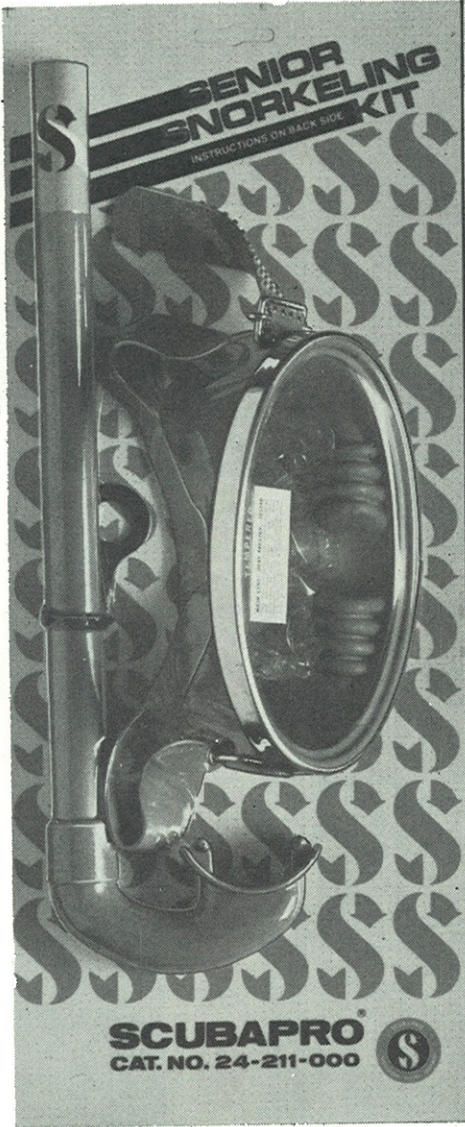
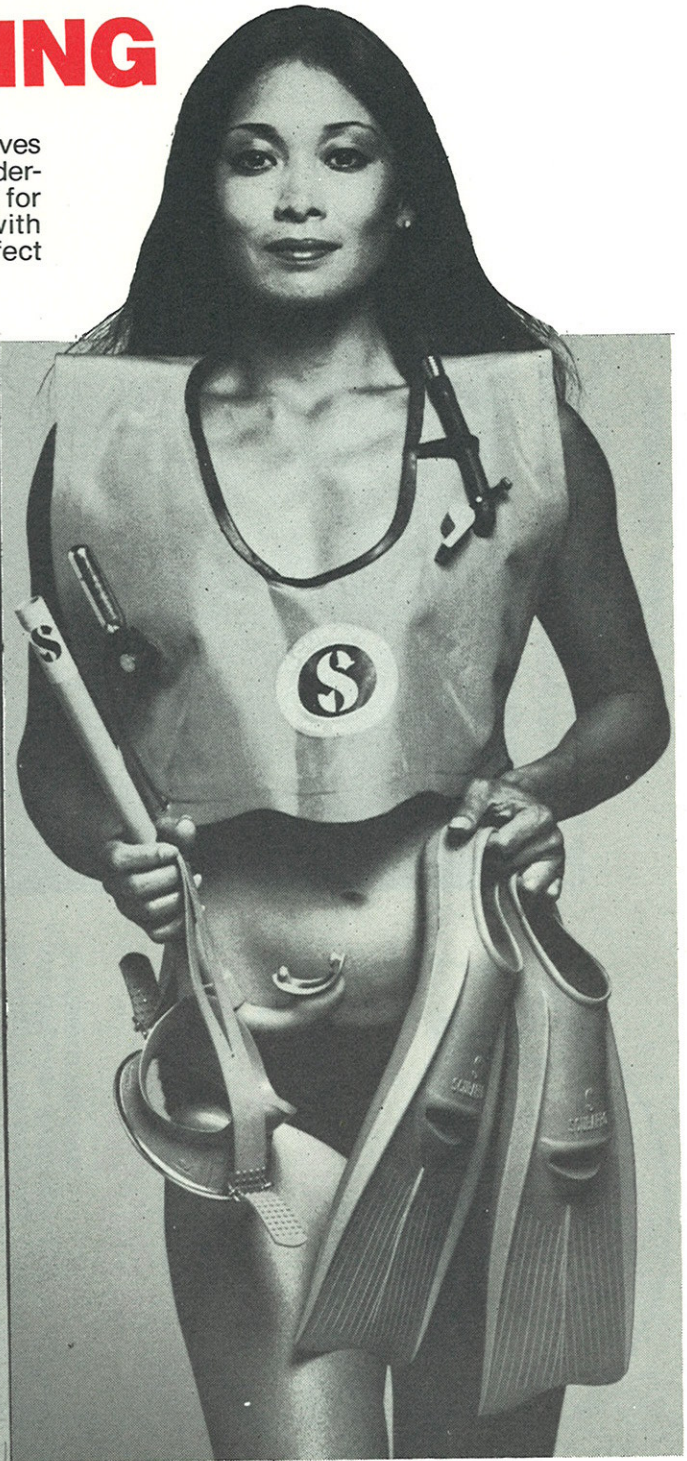

GOOD —IES

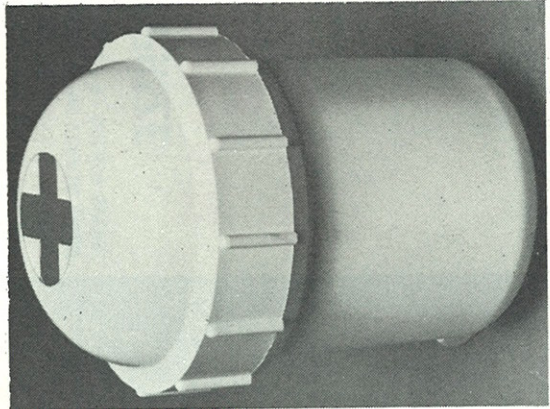

FIRST AID CASE
Waterproof, sealed for pressure and floats.

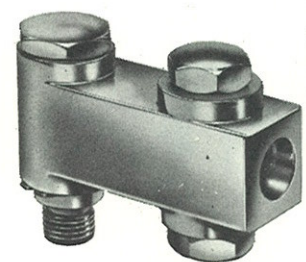

DELUXE UTILITY ADAPTER
Low pressure adapter with three additional low pressure outlets.



UTILITY WRIST STRAP FOR ACCESSORIES



SCUBAPRO BELT BUCKLE
Heavy weight belt buckle 1 3/4" wide.

WEIGHTS
A wide variety of styles in weights contoured for comfort.

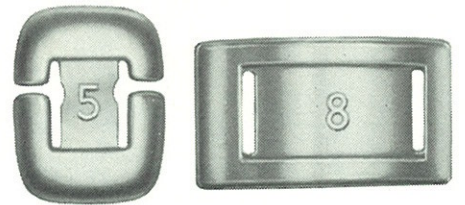

FINEST BUOYANCY SYSTEMS AVAILABLE



Rock'n roll may be here to stay, but Scubapro took it out of diving with the total buoyancy control Stabilizing Jacket. It's the air apparent for heads-up diving technique. And backing up the Stabilizer are beau coup B.C.s like Compensators, Control Packs, The Mark I Diving Vest and Snorkeling Vest.



Wall Thermometer A catchy little number that activates any vacant wall space.

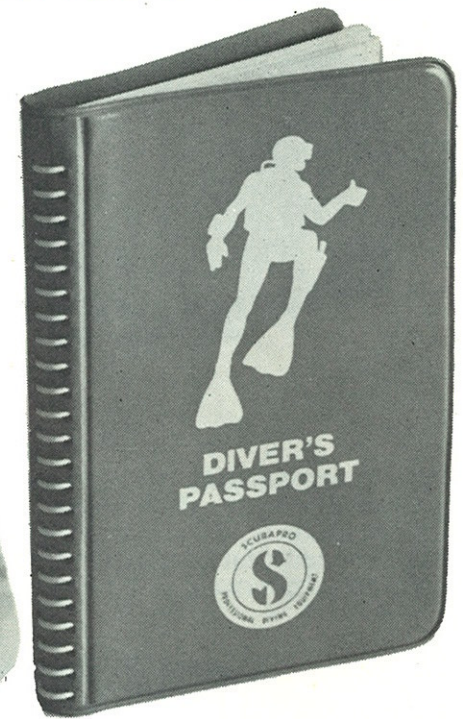

Log Book A way to turn all your yesterdays into tomorrows. Logs in up to 57 dives. A waterproof way to save your memories.

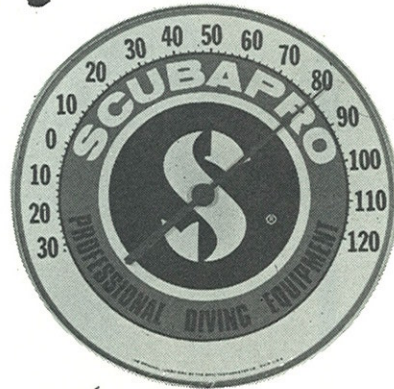

**LIFT/
GAME
BAGS**

FLASHLIGHT

A bright idea for dark moments in diving. A handy item to have around to make you spot more adventure.

SPECIAL WOMEN'S SIZES

All Scubapro Professional Diving Equipment is available in women's sizes—In recognition that divers come in a variety of sizes and shapes.



Scubapro will even carry your catch for you with these handy lift bags. Built-in air pockets will lift loads to the surface or float them back to ship or shore.



**Enter The
Scubapro
Christmas
Sweepstakes**

TANKS AND VALVES

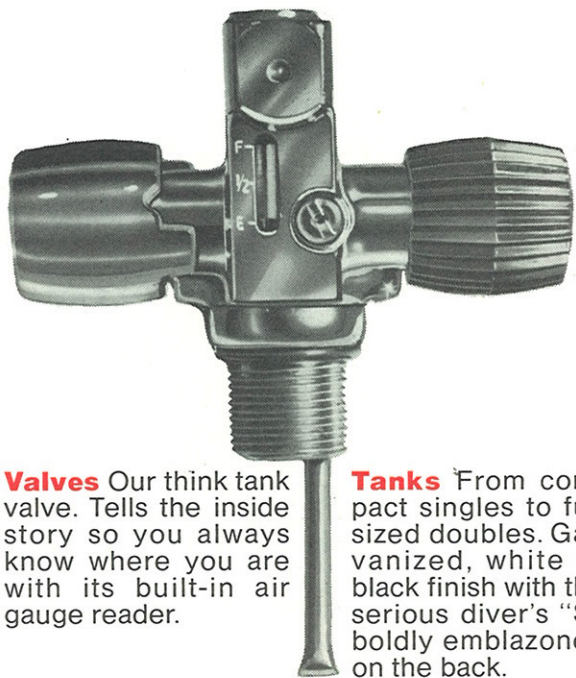

Valves Our think tank valve. Tells the inside story so you always know where you are with its built-in air gauge reader.

Tanks From compact singles to full sized doubles. Galvanized, white or black finish with the serious diver's "S" boldly emblazoned on the back.



MAKES BREATHING BELOW AS EASY AS BREATHING ABOVE

FIRST AND SECOND STAGES ARE BOTH TOTALLY BALANCED FOR TOTAL PERFORMANCE

A DACOR FIRST—AUTOMATICALLY BALANCED SECOND STAGE FOR UNMATCHED BREATHABILITY

Dacor is proud to present a complete new line of PACER® regulators. These *Positive Air Controlled Equalizing Regulators* are not just an improvement but the most important innovation in regulator "breathability" in the 25 years we have been manufacturing diving equipment. Dacor has harnessed a principle of physics known as "Venturi" and invented a revolutionary *Venturamatic* System that completely "air balances" the PACER second stage. At the same time Dacor's *Venturamatic* System controls run-away

"Venturi" flow, surging, and free-flow—which, until now, have been a problem with all high volume regulators. The PACER's smooth laminar flow allows the diver to get the air he needs when he needs it and, at the same time, provides the same smooth, natural respiration as surface breathing at any depth and under the most extreme demand conditions. Dacor's exclusive *Dual Exhaust* feature ideally matches the PACER's large volume inhalation with the 50% easier exhalation effort.

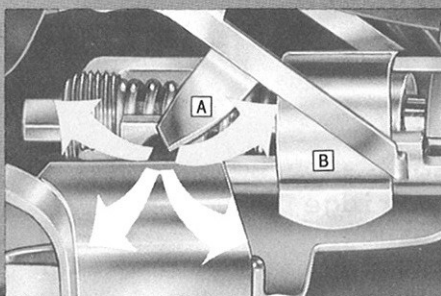

Exclusive Venturamatic™ System (PATENTS PENDING) Here's how it works—As air flow increases with lowering of valve lever, the *Venturamatic Flow Vane* (A), which is an integral part of the lever itself, also lowers and disperses the air stream in amount and direction related to volume of flow to prevent surging and uncontrolled venturi. The *Venturamatic Booster Clip* (B) effectively directs air flow to create and control venturi, making valve opening easier under high volume demand.

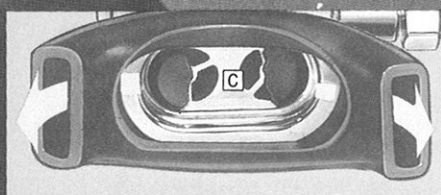

Exclusive Dual Exhaust System Here's how it works—Two large exhaust valves (C) eliminate exhalation resistance and make the PACER 50% easier in exhalation effort and purging.

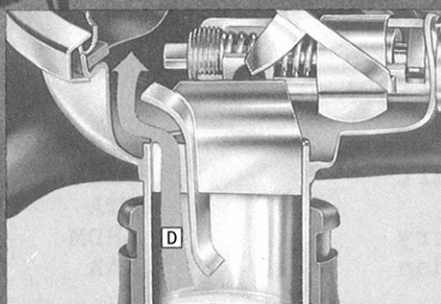

Exclusive Anti-Free Flow Device Here's how it works—When PACER is removed from the mouth underwater, water enters special chamber (D) thus balancing ambient water pressure on internal side of the diaphragm and stopping air flow. This function is automatic and takes a maximum of 3 seconds.



DACOR CORPORATION
161 Northfield Road
Northfield, Illinois 60093
P.O. Box 157

Send \$2.00 for Dacor Diver's Kit. Includes catalog, cloth patch, decomp. table, decals.

dacOR
INNOVATION IN EVERY FEATURE OF PACER'S COMPLETELY NEW FIRST STAGES

PACER FIRST STAGE FEATURE CHART

PACER MODEL NUMBER	900	600	300	150
Balanced diaphragm design	•	•	•	•
Balanced flow-thru piston design	•	•	•	•
Piston with teflon seat and back up rings for maximum sealing	•	•	•	•
Balanced first stage for minimum breathing effort and maximum air flow, regardless of tank pressure	•	•	•	•
Dual spring design provides equal pressure on high pressure diaphragm for smoother first stage opening	•	•	•	•
Swivel attachment yoke for proper alignment of low and high pressure hoses	•	•	•	•
3 low pressure ports on swivel for comfortable alignment of hoses for vest, dry suit or octopus	•	•	•	•
2 high pressure ports, one on each side of first stage allows use of underwater pressure gauge on either side	•	•	•	•
Heavy forged naval brass body, triple chrome plated	•	•	•	•
Heavy brass triple chrome plated body, yoke and yoke screw	•	•	•	•
Optional European din yoke for overseas use	•	•	•	•
Optional silicone hydraulic protection system	•	•	•	•

Men's Division

Largest Catfish: John Wolfkill (not SWC member)

Largest Fish:

1st	Dennis Corcoran	IDA	6 lb. 5 oz.
2nd	James Permenter	IDA	6 lb. 4 oz.
3rd	Jim Woolridge	IDA	5 lb. 15 oz.
4th	Edd Long	ETA	5 lb. 5 oz.

Most Fish:

1st	Charles Crawford	Little Gems	7 fish
2nd	Jim Woolridge	IDA	4 fish
3rd	Larry Patterson	IDA	3 fish
4th	Doyle Pennington	Lawton	2 fish

Team Total Weight:

1st	Swilley/Crawford	Little Gems	25 lb. 6 oz.
2nd	Corcoran/Woolridge	IDA	14 lb. 0 oz.
3rd	Patterson/Kornegay	IDA	10 lb. 8 oz.
4th	Mayes/Pennington	Lawton	9 lb. 4 oz.

Novice Division

No fish

Women's Division

No entries

Scuba Skills (compass run)

1st	Tom Gibson	Hydronauts (not SWC member)
2nd	Susan Stewart	Dallas Divers
3rd	Edd Long	ETA
4th	David McMurry	LHDM
5th	Glen Sheridan	AAA



EDITORIAL

A few thoughts about the SWC convention coming up in February.

All changes must be submitted in writing in time to be published to be eligible to pass by 2/3 vote at convention. All others will be 100% to pass.

In past issues there have been comments to the effect that officers of the SWC need to do the best job possible, and the Slate agrees that this would improve the SWC as an organization. With this in mind, we would hope that the people nominated in the coming year, if elected, would be the type people to take pride in their office and do their best to make the SWC a better organization.

The Editor and Staff of The Slate have tried to do the best job we could on each issue of the Slate. We would hope that in the coming year that the Editor of the Slate has enough help and information to do the job effectively.

ETA as a club has had the opportunity to prove that a group of people with the help of all area V.P.'s can do the job in at least getting what information we get out each month.

Publication of The Slate is one of the more important functions that needs the help of the entire SWC membership clubs. It will be as good as the information it carries. With this in mind the convention should bring about a club willing to take over The Slate with a club effort that has to be effective.

In effect we are asking all clubs to consider their nominees to offices and to support the elected officers with their help.

One person can only do so much without help and support. Since the SWC is made up of groups of people in clubs, this should provide the help needed to each officer elected.

So let's move into the Convention with plans to make 1979 the best year for the SWC and all the clubs that make it up.

Editorial Staff

the "bible" of underwater photography

This is the book that tells it all about the fastest growing interest of divers everywhere. Whether you're a novice photographer or an expert, you'll want to make the most out of the time you spend underwater by capturing your diving experiences on film. Dacor commissioned author Joe Strykowski, who is an expert diver, instructor and photographer, to write an authoritative hard cover volume in a clear, concise style that simplifies theory, techniques and practical methods. **Divers & Cameras** provides full coverage of the entire range of equipment including cameras, lenses, housings, filters, film, light meters, dome ports, macrophotography strobe and flash bulb lighting. Additional chapters cover composition and movie making. Over 150 photos, illustrations, charts and tables are packed into 212 pages. This is a "how to" book.



DACOR CORPORATION
Manufacturers of Diving Equipment
161 Northfield Road
Northfield, IL 60093
P.O. Box 157

AMERICAN AIRLINES
AQUAJETS
Diving Club

ROUTE 3, BOX 183B
ROANOKE, TEXAS 76262

We Support All Activities of
the Southwest Council

President	Secretary-Treasurer
GARY EMBREE	CAROLYN EMBREE



DOOR PRIZES
FOR
EVERYONE

PARTY

TEXAS GAR RODEO
IN MEMORY OF
JIM CLARK

IN 1961 JIM CLARK PRESIDENT OF THE ARK-LA-TEX DIVERS, WAS ACCIDENTLY KILLED BY A HUNTER WHO MISTOOK HIM FOR AN ALLIGATOR. THE JIM CLARK MEMORIAL GAR RODEO WAS ESTABLISHED BY THE SOUTHWEST COUNCIL OF DIVING CLUBS ON AN ANNUAL BASIS IN HIS MEMORY AND IS ALWAYS HOSTED BY THE EAST TEXAS AQUANAUTS OF LONGVIEW, TEXAS

TRADITIONAL
CYPRESS KNEE
TROPHIES

FREE BEER

SOUTHWEST COUNCIL SANCTIONED
DECEMBER 9th & 10th
CURLEY'S CAMP
CADDO LAKE - UNCERTAIN, TEX.

DALLAS DIVERS QUENTON BECKET MEMORIAL PHOTOGRAPHY CONTEST AND WORKSHOP
(SWC SANCTIONED FUNCTION)

Color Slides

1st Ed Ralston
2nd Ed Ralston
3rd Ed Ralston
4th Byron Darby

Macro Color Slides

1st Ed Ralston
2nd Ed Ralston
3rd Ed Ralston

Fresh Water Slides

1st Ed Ralston
2nd Ed Ralston
3rd Ed Ralston

Slide Series

1st John Lee
2nd Byron Darby

Surface Slide

1st Ed Ralston

Black & White Prints

1st Glen Sheridan
2nd Glen Sheridan
3rd Glen Sheridan

Macro Color Prints

1st Ed Ralston
2nd Ed Ralston
3rd Ed Ralston

Color Prints

1st Byron Darby
2nd Odin Straatveit
3rd Odin Straatveit
4th Odin Straatveit

Novice Color Prints

1st Byron Darby
2nd Byron Darby
3rd Byron Darby

Sound Motion Pictures

1st Gene Gall

Silent Motion Pictures

1st Galloway Darby

PRESIDENT'S REPORT

Dear Slate and fellow divers,

Hope to find everyone doing well and wet. Sept. 15-16 the Longview Dive Shop chartered The Silver King II for a weekend of fantastic weather and smooth seas. We had a great B.S. session, with well known watermen Weasel Woods, Don Sibley, and my little buddy Edd Long contributing words of wisdom about sea snakes on the oil rigs. We were about drained of energy by the time we hit the jetty's due to continual bombardment of six inch mosquitos, the big ones always get away. By sunrise everyone was getting gear ready for the water, except for ole Reg Ormsby, little did he know that the water was getting ready for him. Ole Reg had us fooled for a while cause he said he was chumming for sharks. Hang in there Reg, I mean hang over there Reg. By the time we hit the first rig several people were helping Reg chum for sharks. Edd wanted to help but Weasel and I held him back for an all time FIRST. To make a long story short we had a very good weekend and shot lots of snapper. Bill Roden was modeling the latest fashions in rig diving apparel, for fashion debut ask BILL.

Sept. 23-24, the Lawton Divers put on their annual Catfish Roundup at beautiful Lake Murray. The accommodations were great, the lake was fantastic, the food superb, but NO FISH. Our Thanks to the Lawton Divers for another fine event. Well, the Lawton Dive ended the year for the contestants of all scuba skills event, with one more event for all the spearfishermen at the ever trying COLD CADD0. This year I'm hoping for about 1 inch of ice on the lake, just to make it sporting.

In case ya'll don't know, one of our top spearfishermen this year and dear friend is having serious foot surgery and will not be able to attend Caddo. We wish a speedy recovery to ya Larry Patterson. Probably by the time it is all over, Gay will be the one who will need the most help. Anyhow Good Luck, Larry.

Our Thanks also goes to the Dallas Divers for their annual "Quentin Becket Memorial Photo Contest." For ALL you who did not attend I can honestly say You missed a Treat. They had several displays of various diving sites. Wayne Mathewson had a display of plexi-glas camera housing and novelties. Jim Mularky had a display on Salvage Diving in the Great Lakes with histreasures he found and a slide presentation to follow. I thought The Dallas Divers had a wide variety of beautiful prints and slides and the most unusual trophies I've ever seen. Thanks again for another great Photo contest.

Well so long for now and I hope to see you all at The Gar Rodeo in December.

Goodnite Larry.

Don't Wait ... Communicate.

Glen Sheridan
President, Southwest Council

- YMCA PADI INSTRUCTION
- CHARTER TRIPS
- DIVING VACATIONS

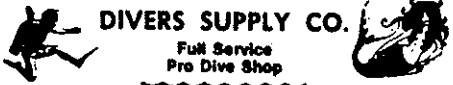

DIVERS SUPPLY CO.
Full Service
Pro Dive Shop

103 E. Melton
Longview, Texas 75602
(214) 757-8112
LARRY SMITH, Owner



SOUTHWEST COUNCIL OF DIVING CLUBS

Membership into this Council

Send the following to:

GLENN SHERIDAN, 3620 Harvard, Irving, Tx. 75062
Phone 1/214/255-7836.



1. Copy of Club's Constitution and/or By-laws.
2. Membership list of club including names, addresses and designated officers.
3. Membership fee (\$20.00 for the club and \$6.00 per individual).

Membership in the Council is from January 1st thru December 31st, at which time dues become due. However, there is a grace period of 3 months, January 1st thru March 31st, at which time dues expire. Dues may be paid in December of the previous year and will be for the ensuing year if the membership is not used for any Council activity before January 1st.

INFORMATION ABOUT THE COUNCIL

Anyone wishing information about the Council, its activities, ect., should send inquiries to the President or any officer in your general area. Refer to the inside for a list of officers, mailing addresses and phone numbers.

SUBSCRIBE TO THE "SOUTHWEST SLATE"

Subscription is free to members of the Council, rates to non-members are 35¢ per copy or \$3.50 per year. Mail subscriptions to Bill Roden P.O. 2268 Longview, Tx. 75601.

NEWSLETTER

The "Southwest Slate" is the voice of the Southwest Council of Diving Clubs and is published monthly. Articles in the "Slate" may be reproduced in full or part (unless otherwise specified) as long as credit is given to the "Slate" and authors of the articles.

"NOTICE"

Articles and pictures for publication in the "Slate" must be in by the 10th of each month as the publication date will be approximately the 15th of each month. Send all material to "Slate" P.O. 2268 Longview, Tx. 75601.

SLATE

PO.BOX2268
LONGVIEW, TX 75601

Postage
U.S. Bulk Rate
Permit # 24
Longview, Tx.
75601

Bart A. McCollum
3325 Providence
Midland, Tx 79703

