

Nov  
1978

THE

# SLATE

**SAFETY  
LEGISLATION  
CONSERVATION**

**PHOTOGRAPHY  
SCUBA SKILLS  
SPEARFISHING**



**Voice of Southwest Council of Diving Clubs**



NOVEMBER 1978

SLATE STAFF

Managing Editor: Bill Roden  
 Asst. Editors: Dennis Fogarty  
 Larry Smith  
 Edd Long  
 Elizabeth Saunders  
 Typist: Elizabeth Saunders  
 Production Assistants: Nancy Beard  
 Wade Garvin  
 Jeff Jones

PRESIDENT'S REPORT

Dear Slate and Diving Friends:

Well the end of another great diving year is drawing to an end. The final contest is the "COLD CADDO".

The officers of the SWC will host the second Photo Contest prior to the Convention in February, with the winning entries on display at the convention.

I was digging through some old files in the President's file cabinet and was so astounded that I thought I would write my findings. This is the list of paid clubs in the SWC in 1964.

- Amarillo Skin Divers
- Aquatic Sports
- Ark La Tex Divers
- Austin Underwater Society
- Alamo Barracudas
- Carthage Scuba Divers
- Carswell Divers
- Coastal Divers
- Dallas Divers
- Dallas Fire Divers
- Diving Rebels
- East Texas Aquanauts
- Garland Divers
- Desert Divers
- Four Corners Divers
- Lake Highland Divers
- Central Texas Divers
- Gulf State Divers
- Inland Divers Assoc.
- Irving Sea Lions
- Kelp Rats
- Lone Star Divers
- L.H.D.M.
- LTV
- Longview Scuba Divers
- Lubbock Dusty Divers
- North Texas Divers
- South Padre Island Divers
- Texin Divers
- Vikings of Ft. Worth
- Duncanville Divers
- Irving Police Divers
- Skin and Scuba Diving Club
- Henderson Water Rats
- U of T Skin & Scuba Diving Society





OFFICIAL BOARD MEETING  
 LAKE CADDO DIVE  
 December 9, 1978  
 7:30 PM sharp!  
 In the game room

/s/ Glen Sheridan



415 WALTER  
LONGVIEW, TEXAS 75603

100% SOUTHWEST  
COUNCIL MEMBERSHIP

AMAZING ISN'T IT??????  
Hope to see ya at Caddo

Glen Sheridan



DOOR PRIZES  
FOR  
EVERYONE  
PARTY

TEXAS GAR RODEO  
IN MEMORY OF  
JIM CLARK

*IN 1961 JIM CLARK PRESIDENT OF THE ARK-LA-TEX DIVERS, WAS ACCIDENTLY KILLED BY A HUNTER WHO MISTOOK HIM FOR AN ALLIGATOR. THE JIM CLARK MEMORIAL GAR RODEO WAS ESTABLISHED BY THE SOUTHWEST COUNCIL OF DIVING CLUBS ON AN ANNUAL BASIS IN HIS MEMORY AND IS ALWAYS HOSTED BY THE EAST TEXAS AQUANAUTS OF LONGVIEW, TEXAS*

TRADITIONAL  
CYPRESS KNEE  
TROPHIES  
FREE BEER

SOUTHWEST COUNCIL SANCTIONED  
DECEMBER 9<sup>th</sup> + 10<sup>th</sup>  
CURLEY'S CAMP  
CADDO LAKE - UNCERTAIN, TEX.

**the "bible" of  
underwater  
photography**

This is the book that tells it all about the fastest growing interest of divers everywhere. Whether you're a novice photographer or an expert, you'll want to make the most out of the time you spend underwater by capturing your diving experiences on film. Dacor commissioned author Joe Strykowski, who is an expert diver, instructor and photographer, to write an authoritative hard cover volume in a clear, concise style that simplifies theory, techniques and practical methods. **Divers & Cameras** provides full coverage of the entire range of equipment including cameras, lenses, housings, filters, film, light meters, dome ports, macrophotography strobe and flash bulb lighting. Additional chapters cover composition and movie making. Over 150 photos, illustrations, charts and tables are packed into 212 pages. This is a "how to" book.

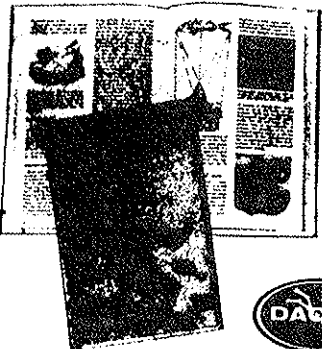

**DACOR CORPORATION**  
Manufacturers of Diving Equipment  
161 Northfield Road  
Northfield, IL 60093  
P.O. Box 157



Dear Officers and Area Vice-Presidents:

The fiscal year and the last diving contest for 1978 is steadily drawing to a close. This is the time to be preparing for any amendments and/or changes to be made to the SWC Constitution and By-Laws. Remember all amendments must be in to the secretary, dated and post-marked November 30, 1978.

Send all amendments to: Sandra Matthews  
116 Charlene  
Hurst, Texas 76053

Also, we should be thinking ahead for new officers for the upcoming year, 1978 Service Award, and 1978 Diver of the Year Award

/s/ Glen Sheridan, President

# ALL NEW DACOR PACER...\*

## \*POSITIVE AIR CONTROLLED EQUALIZING REGULATOR™

PATENTS PENDING

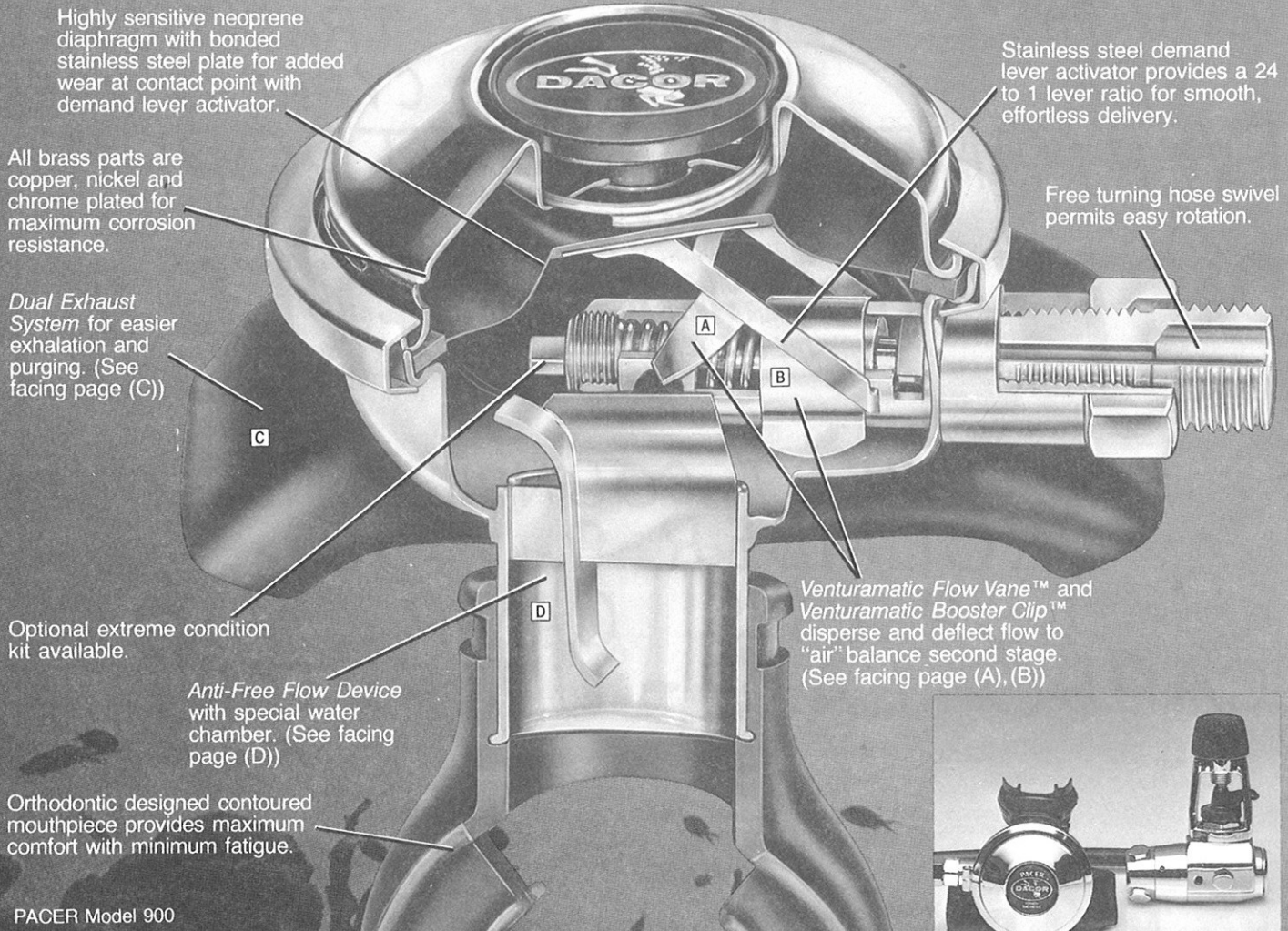

Highly sensitive neoprene diaphragm with bonded stainless steel plate for added wear at contact point with demand lever activator.

Stainless steel demand lever activator provides a 24 to 1 lever ratio for smooth, effortless delivery.

All brass parts are copper, nickel and chrome plated for maximum corrosion resistance.

Free turning hose swivel permits easy rotation.

Dual Exhaust System for easier exhalation and purging. (See facing page (C))

C

Optional extreme condition kit available.

Anti-Free Flow Device with special water chamber. (See facing page (D))

D

Venturamatic Flow Vane™ and Venturamatic Booster Clip™ disperse and deflect flow to "air" balance second stage. (See facing page (A), (B))

Orthodontic designed contoured mouthpiece provides maximum comfort with minimum fatigue.

PACER Model 900

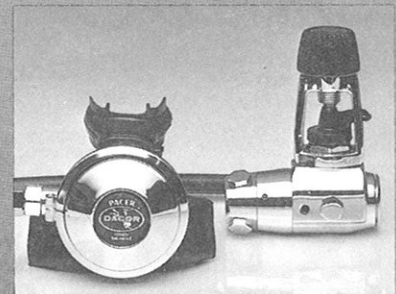
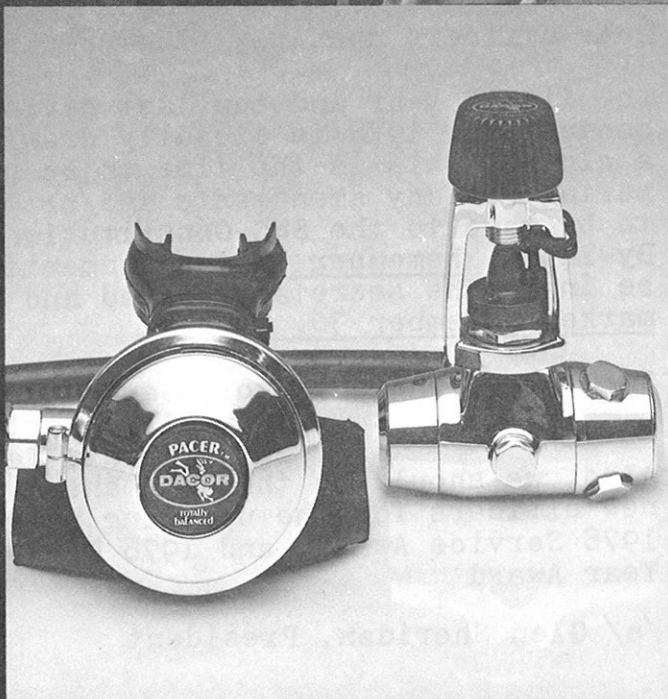

PACER Model 600

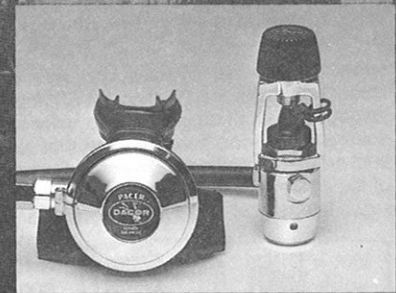

PACER Model 300



PACER Model 150

**A  
WHOLE NEW  
GENERATION  
OF REGULATORS  
THAT INCREASE  
YOUR COMFORT,  
CONFIDENCE,  
AND  
DIVE TIME.**

DEMA SHOW SOLD OUT

All exhibit space for the 1979 DEMA Trade Show and Convention has been completely sold out for three months, making this the largest exhibition of scuba diving equipment to date. 174 booths will be spread over 33,000 square feet of floor space in the Grand Hotel, New Orleans - January 20-23. Dive store dealers and sporting goods retailers will be able to preview the entire 1979 lines of all major U.S. manufacturers of scuba equipment, a wide assortment of diving related products such as boats, camera equipment and clothing, and some European lines of scuba gear. Repair clinics will be held by various manufacturers, instructional organizations (such as NAUI, PADI, NASDS) will demonstrate the latest technique in diver education, and there will be seminars to help the diving retailer gauge his business.



DEMA has also scheduled several social events, so that the retailer can meet and talk with the manufacturer. On Friday, January 20, DEMA's cocktail party will feature Dick Anderson and two of his classic films, "Gold from the Winfield Scott," and "Mac the Dog." On Saturday morning, PADI will hold its breakfast. That evening, SKIN DIVER MAGAZINE will stage its cocktail party. There will be entertainment of sorts in the exhibits, too. At press time, David Doubilet, internationally acclaimed underwater photographer and staff photographer for National Geographic, was scheduled to present his slides on the Red Sea, for an exhibitor who runs dive trips to that part of the world.

Other notes: DEMA will premiere at the show its new quarterly publication, DEMA NEWS, which will serve as a direct communications link between manufacturer and dealer, about DEMA business and activities; also available at the show - Blueprint for Growth, the results of a nationwide survey

of dive store business, designed to help the individual retailer.

The big sideline attraction to the DEMA show is New Orleans itself. This is one of the world's most exciting cities, with fabulous restaurants and plantations, its good southern hospitality, its famed French Quarter and Bourbon Street - and the Mississippi steamboats. The host hotel for the DEMA event is the Grand Hotel, located on historic Canal Street, just a quick walk from the French Quarter. Because of the enormous response to the 1979 show, DEMA has made arrangements with several other hotels in the immediate area of the Grand Hotel, for overflow accommodations.

For registration forms and information, contact DEMA, P. O. Box 4067, Irvine, California 92716.

<p>• YMCA PADI INSTRUCTION</p>	<p>• CHARTER TRIPS • DIVING VACATIONS</p>
 <p><b>DIVERS SUPPLY CO.</b> Full Service Pre Dive Shop</p>	
<p>103 E. Melton Longview, Texas 75602 (214) 757-6112 LARRY SMITH, Owner</p>	
	

H A L L O F S H A M E

The following people failed to represent your club in the November Slate:

- Larry Patterson, Area 2 V-P
- Bart McCollum, Area 4 V-P
- Jeep Valenti, Area 7 V-P

AREA VI REPORT

I'm glad I was able to attend the November club meeting of the East Texas Aquanauts. The meeting seemed to be a little low in attendance. I hope this improves or the Aquanauts might end up with no one in attendance but the officers and their mates. Come on Aquanauts, pep up and try to attend the Gar Rodeo!

The Gar Rodeo will be the last SWC dive for 1978. I just hope there will be some water in Caddo Lake by the Gar Rodeo weekend. Hope as many of the SWC members as possible will be able to attend. How about it Blue Ridge Divers?

It won't be long until we elect new SWC officers. I hope everyone will consider what David McMurry and others have suggested. Please don't vote for the "good ole boy", but vote for the individual who is willing to help the SWC.

Aquanaut Robert Lightfoot and wife, Kim, have a new member in their family. Geoffrey Chad Lightfoot was born November 15, 1978.

Dennis Fogarty, Area 6 V-P



observations thru a flooded mask

"Why in hell can't we get interested in something other than diving; like sex, or golf. I read recently that sex helps maintain good muscle tone." Nothing wrong with the muscle tone of this group. I wonder how they do it.

Maze BATHROOM PUZZLE

SEA HORSE

Rated Time Limit/3:00

From  
**Aqualine**

The seahorse's tail can be curled around seaweeds, etc. for support. The father gives birth to the young. Seahorses live in a vertical position, swimming by rapidly moving their fins.

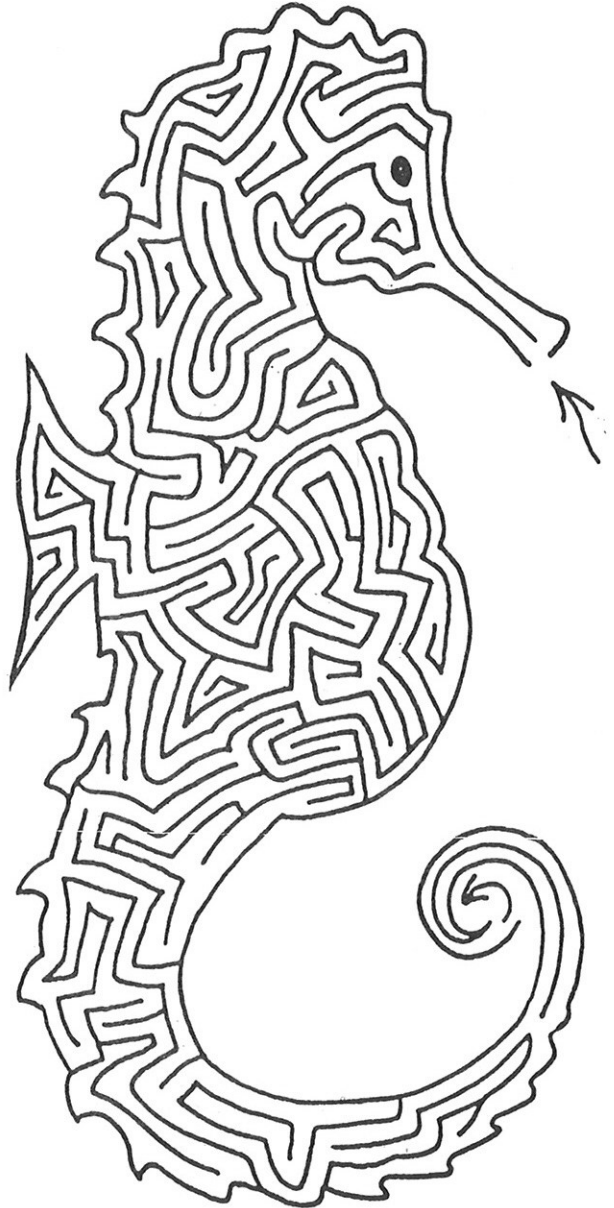

**HOW TO BUILD YOUR OWN POWER SLING**

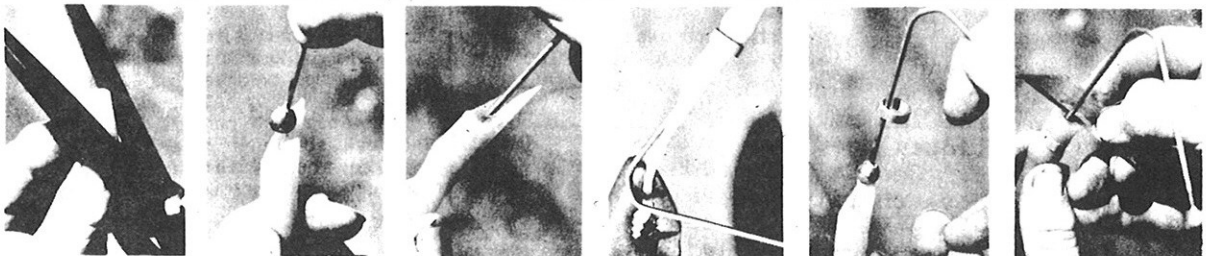

**Necessary tools:** large scizzors or razor, wishbone and 2 rings, vice, or a second person to help, pliers, surgical tubing. **Step #1** Cut tubing to the desired length, then with a sharp re-

the tubing into a vice, locking it about 2" down from the ball. Slide the ring over the wishbone and, with pliers, stretch the tubing out. At the same time, slide the ring up against the ball. **Step #5** Slide the

# MAKES BREATHING BELOW AS EASY AS BREATHING ABOVE

**FIRST AND SECOND STAGES ARE BOTH TOTALLY BALANCED FOR TOTAL PERFORMANCE**

**A DACOR FIRST—AUTOMATICALLY BALANCED SECOND STAGE FOR UNMATCHED BREATHABILITY**

Dacor is proud to present a complete new line of PACER® regulators. These *Positive Air Controlled Equalizing Regulators* are not just an improvement but the most important innovation in regulator "breathability" in the 25 years we have been manufacturing diving equipment. Dacor has harnessed a principle of physics known as "Venturi" and invented a revolutionary *Venturamatic* System that completely "air balances" the PACER second stage. At the same time Dacor's *Venturamatic* System controls run-away

"Venturi" flow, surging, and free-flow—which, until now, have been a problem with all high volume regulators. The PACER's smooth laminar flow allows the diver to get the air he needs when he needs it and, at the same time, provides the same smooth, natural respiration as surface breathing at any depth and under the most extreme demand conditions. Dacor's exclusive *Dual Exhaust* feature ideally matches the PACER's large volume inhalation with the 50% easier exhalation effort.

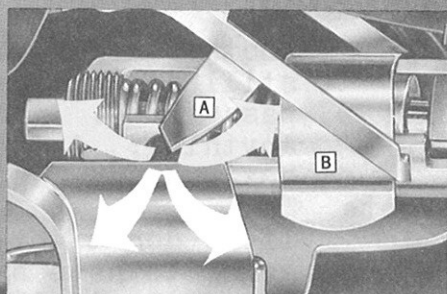

**Exclusive Venturamatic™ System (PATENTS PENDING)** Here's how it works—As air flow increases with lowering of valve lever, the *Venturamatic Flow Vane (A)*, which is an integral part of the lever itself, also lowers and disperses the air stream in amount and direction related to volume of flow to prevent surging and uncontrolled venturi. The *Venturamatic Booster Clip (B)* effectively directs air flow to create and control venturi, making valve opening easier under high volume demand.

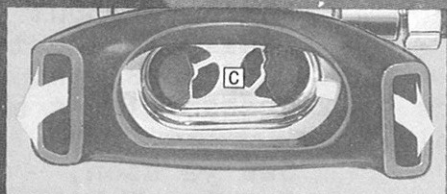

**Exclusive Dual Exhaust System** Here's how it works—Two large exhaust valves (C) eliminate exhalation resistance and make the PACER 50% easier in exhalation effort and purging.

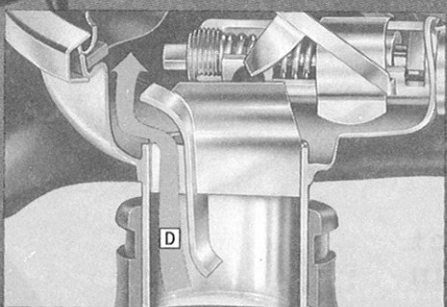

**Exclusive Anti-Free Flow Device** Here's how it works—When PACER is removed from the mouth underwater, water enters special chamber (D) thus balancing ambient water pressure on internal side of the diaphragm and stopping air flow. This function is automatic and takes a maximum of 3 seconds.



**DACOR CORPORATION**  
161 Northfield Road  
Northfield, Illinois 60093  
P.O. Box 157

Send \$2.00 for Dacor Diver's Kit. Includes catalog, cloth patch, decomp. table, decals.

**dacOR INNOVATION IN EVERY FEATURE OF PACER'S COMPLETELY NEW FIRST STAGES**

## PACER FIRST STAGE FEATURE CHART

PACER MODEL NUMBER	900	600	300	150
Balanced diaphragm design	•	•	•	•
Balanced flow-thru piston design	•	•	•	•
Piston with teflon seat and back up rings for maximum sealing	•	•	•	•
Balanced first stage for minimum breathing effort and maximum air flow, regardless of tank pressure	•	•	•	•
Dual spring design provides equal pressure on high pressure diaphragm for smoother first stage opening	•	•	•	•
Swivel attachment yoke for proper alignment of low and high pressure hoses	•	•	•	•
3 low pressure ports on swivel for comfortable alignment of hoses for vest, dry suit or octopus	•	•	•	•
2 high pressure ports, one on each side of first stage allows use of underwater pressure gauge on either side	•	•	•	•
Heavy forged naval brass body, triple chrome plated	•	•	•	•
Heavy brass triple chrome plated body, yoke and yoke screw	•	•	•	•
Optional European din yoke for overseas use	•	•	•	•
Optional silicone hydraulic protection system	•	•	•	•

By the time you read this, the Dallas Divers' First Annual Dive-In will be past history. Hopefully many of you will have gone and derived much benefit. Thanks again to the Dallas Divers.

I'M sorry to report that there aren't many dive related activities planned for the near future in Area I. However, this will give me an opportunity to get on the soap box again.

We need your help. Those of you who haven't held office in the SWC and who feel a desire to participate should do their research now. Talk to the current officers and find out what they do.

You may ask: Why should I actively participate in organized diving? Let me answer with the objectives of the Les Hommes De Mer Dive Club....

1. to form an organization to promote more interest in the sport of skin diving with particular emphasis on public service and competitive events.
2. to form an organization that will act in cooperation with others to encourage legislation favorable to the sport.
3. to form an organization to encourage young people to enter the fields of science which will add to man's knowledge of the sea and it's life.
4. to form an organization to act as a unit to promote safety in the sport.
5. to form an organization which will lend itself to any valid scientific research or conservation effort
6. to sponsor fellowship and clean living and to promote the sport of skin diving, parties, outings, contests and related activities in the furtherance of good sportsmanship.

You can help the SWC to stay active, to grow and to be responsive to the needs of the diving community.

There are two Area III Reports in this month's Slate because the October report was not postmarked until the 10th and therefore not received in time for publication in the October issue.

#### AREA III REPORT (October)

American Airlines Aquajets is not having any meetings or activities at the present time. Everyone has other interests right now.

No news from LTV.

See you soon,  
Carolyn Embree, Area 3 V-P

#### AREA III REPORT (November)

Another month has come and gone and I still don't have any diving news to pass along. AAA and LTV aren't doing anything. A few members are getting anxious for Caddo.

If we don't get some rain, we are not going to have any lakes left in our area. Lewisville Lake and Grapevine Lake are about 12' low. You have to really look out for tree stumps and sand bars, and the boat ramps aren't accessible at all.

See ya soon,  
Carolyn Embree, Area 3 V-P



CUT OUT  
FOR  
ADVENTURE

Are you up tight, so busy making a living that sometimes you forget how to live? If you're like most people, you hardly have time. Too busy meeting deadlines, trying to get it all in before it's all over. Well, it's time you realize this isn't a dress rehearsal. This is your life. Enjoy it now, you only go around once.

LEARN TO SCUBA DIVE AND JOIN  
THE BEAUTIFUL, SILENT UNDERWATER WORLD.

PHONE 214 - 787-6118

• Bales • Rentals • Air • Photography •  
Boat Dives • Advance and Specialty  
Instruction • Diving Vacations • Charters

Divers Supply Co

102 E. MELTON, LONGVIEW, TEXAS



SOUTHWEST COUNCIL OFFICERS & VICE PRESIDENTS

Glen Sheridan, President  
1904 Anna Drive  
Irving, Texas 75061  
214/438-5737

Bart Mc Collum, Vice Pres., Area 4  
3325 Providence  
Midland, Texas 79701  
915/694-8948

Edd Long, Exec. Vice-Pres.  
P.O. Box 801  
Gladewater, Texas 75647  
214/845-3652

Dennis Fogarty, Vice Pres., Area 6  
Route 3, Box 520  
Longview, Texas 75603  
214/643-2061

Sandra Matthews, Secretary  
116 Charlene  
Hurst, Texas 76053  
817/282-3082

Jeep Valenti, Vice Pres., Area 7  
903 S.W. 49  
Lawton, Oklahoma 73505  
405/353-0157

Myrna Jorgensen, Treasurer  
2805 Great Valley  
Leander, Texas 78641  
512/258-6494

Deryle Matthews, Director  
116 Charlene  
Hurst, Texas 76053  
817/282-3082

Bill Roden, Slate Editor  
P.O. Box 2268  
Longview, Texas 75601  
214/753-0178

Robert Swilley, Director  
Box 308  
Waskum, Texas 76892  
214/687-2727

Ed Ralston, Underwater Society Rep.  
3401 N. Meridian Ct.  
Oklahoma City, Oklahoma 73122  
405/942-0252

These are addresses of officers and area Vice Presidents in the Southwest Council.  
Any information about clubs or council activities, contact the closest officer in your area.

Gordon Hubenak, Public Relations  
4324 Keeter Dr.  
Ft. Worth, Texas 76118  
817/589-2377

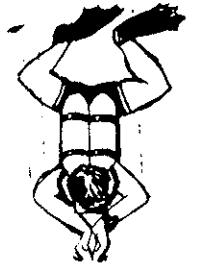

Dave Mc Murry, Vice President Area 1  
2525 Santa Cruz  
Dallas, Texas 75227  
214/381-3045

Larry Patterson, Vice Pres., Area 2  
Rt. 1, 15 Tower Ct.  
Crowley, Texas 76036  
817/297-4752

Carolyn Embree, Vice Pres., Area 3  
Rt. 3, Box 183B  
Roanoke, Texas 76262  
817/430-1254

**AMERICAN AIRLINES**  
**AQUAJETS**  
**Diving Club**

**ROUTE 3, BOX 183B**  
**ROANOKE, TEXAS 76262**

**We Support All Activities of**  
**the Southwest Council**

President  
**GARY**

Secretary-Treasurer  
**CAROLYN**

SOUTHWEST COUNCIL OF DIVING CLUBS

Membership into this Council

Send the following to:

GLENN SHERIDAN, 3620 Harvard, Irving, Tx. 75062  
Phone 1/214/255-7836.



1. Copy of Club's Constitution and/or By-laws.
2. Membership list of club including names, addresses and designated officers.
3. Membership fee (\$20.00 for the club and \$6.00 per individual).

Membership in the Council is from January 1st thru December 31st, at which time dues become due. However, there is a grace period of 3 months, January 1st thru March 31st, at which time dues expire. Dues may be paid in December of the previous year and will be for the ensuing year if the membership is not used for any Council activity before January 1st.

INFORMATION ABOUT THE COUNCIL

Anyone wishing information about the Council, its activities, ect., should send inquiries to the President or any officer in your general area. Refer to the inside for a list of officers, mailing addresses and phone numbers.

SUBSCRIBE TO THE "SOUTHWEST SLATE"

Subscription is free to members of the Council, rates to non-members are 35¢ per copy or \$3.50 per year. Mail subscriptions to Bill Roden P.O. 2268 Longview, Tx. 75601.

NEWSLETTER

The "Southwest Slate" is the voice of the Southwest Council of Diving Clubs and is published monthly. Articles in the "Slate" may be reproduced in full or part (unless otherwise specified) as long as credit is given to the "Slate" and authors of the articles.

"NOTICE"

Articles and pictures for publication in the "Slate" must be in by the 10th of each month as the publication date will be approximately the 15th of each month. Send all material to "Slate" P.O. 2268 Longview, Tx. 75601.

# SLATE

PO.BOX2268  
LONGVIEW, TX 75601

Postage  
U.S. Bulk Rate  
Permit # 24  
Longview, Tx.  
75601

Bart A. McCollum  
3325 Providence  
Midland, Tx 79703

