

March 1979

THE
SLATE

**SAFETY
LEGISLATION
CONSERVATION**

**PHOTOGRAPHY
SCUBA SKILLS
SPEARFISHING**



Voice of Southwest Council of Diving Clubs



+++++ AREA 5 REPORT +++++

We attended a dive club meeting in Waco with the BRAZOS VALLEY DIVERS in February. The club had a good turnout for just beginning with about 20 folks there. I was invited to address the club in reference to the SWC and USA as to how the club would benefit by joining. With the help of Myrna Jorgensen and Lewis Pack, the club decided to present their constitution to the SWC for membership which will be presented to the Board meeting at the LHDM dive in March. Welcome BRAZOS VALLEY DIVERS! All you other clubs and members drop by and say HI and welcome to the Council.

The Cen Tex Divers had their monthly meeting March 1st with 10 members present. They have set a goal of six club dives with at least two being night dives along with compass and spearfishing contests and a possible challenge dive with those "Devil" Texins of Dallas sometime in September.

Lake Travis Report! Only 9 foot low now (up from 25 foot low) with water temperature of 52 degrees F. Visibility poor (1 foot to 7 feet) due to the rising level. Only a little of one island showing now and it should be gone by the Safari.

See you in the water!!

Ron Jorgensen, Area 5 Vice-President

The Slate will run classified ads for individuals wishing to sell scuba gear, boating equipment, etc. The cost for an ad is \$2.00 for a maximum of 25 words. Send your ad to the address shown on the back cover or call 214/692-7714.



+++++ AREA 1 REPORT +++++

Thank you to LHDM for a well-organized dive. It's too bad the weather did not cooperate on Saturday but Sunday was a beautiful day for a dive. Wayne Mathewson was the hit of the compass run with his board straight out of Star Wars.

All Area 1 clubs are busy preparing their diving calendars for 1979. As for ocean trips, it looks as if both Dallas Divers and Texins will be taking their summer trips to Cozumel at different times. Texins' Divemaster class is planning a trip to the Flower Gardens in June and inviting other members of the club to go along. LHDM members are planning a Gulf trip with Carl Garrison.

Looking forward to the IDA competition.

See you diving,

Susan Stewart, Area 1 Vice-President

+++++ AREA 6 REPORT +++++

The activities occurring in our area are limited at this time of year. The area lakes are generally murky due to excess rainfall and this does not encourage diving.

The Aquanauts and I hope the Blue Ridge Divers are looking forward to the first SWC dive at P.K. ETA's club meeting is scheduled for March 14th at which time dives for the year will be discussed and planned out on a calendar basis.

The officers of the club have formulated a basic date for each dive spaced between the SWC events for the year.

One such dive to be discussed is a Gulf trip which will be planned in a way that will be the least expensive to the members who make the dive.

I do not have any information from the Blue Ridge Divers at this time but hope to include their club activities in the next Slate.

With the best interest of diving in mind, here's to clear, clean water, and the time to take advantage of it.

Yours sincerely,

Clyde Cole, Area 6 Vice-President

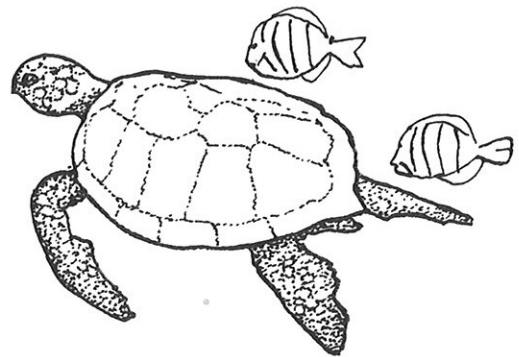
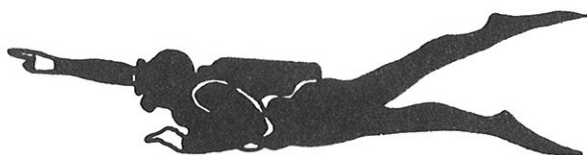

TREASURER'S REPORT

1/29/79 to 3/7/79

Cash on hand 1/29/79 \$1,132.80

INCOME

Sanction Fees:
 Gar Rodeo '77 \$ 37.00
 LTV '78 68.50
 Lawton '78 70.00
 SWC Photo Contest 63.50
 Club Dues (4 @ \$20) 80.00
 Member Dues (20 @ \$10) 200.00
 SWC Patches (10 @ \$1.50) 15.00

15.00 \$ 534.00

Cash Available \$1,666.80

DISBURSEMENTS

Printing constitution and proposals \$ 178.51
 3 Patches for '77 Nat'ls. 6.00
 Engrave Convention Trophies 38.40
 USA - Sanction Fees '79 7.00
 USA - 20 member dues 100.00
 DAF - Proceeds from:
 '77 Gar Rodeo \$37.00
 '78 Gar Rodeo 14.50 51.50
 Slate Oct/Nov \$183.76
 Dec/Jan 183.76 367.52
 Postage - Slate 50.00
 Photos for Slate 13.92
 Bonus to B. Roden for Slate 250.00
 \$1,062.85

Cash on hand 3/7/79 \$ 603.95

Nationals Savings Account \$300.00
 DAF Savings Account 183.19

/s/ Myrna Jorgensen, Treasurer

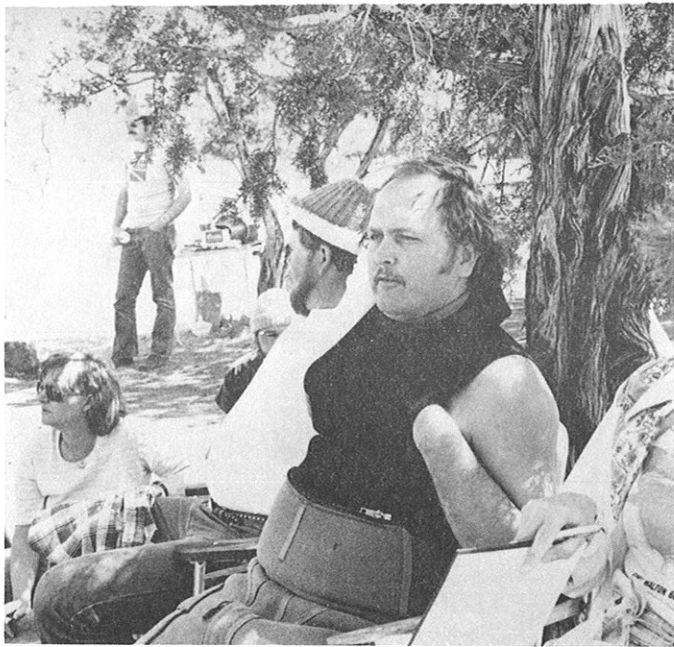

Should we compare our 1979 SWC President with Napoleon?



"Mommy! Will they save these women's trophies for me?"



Bill Welch of Davis, Oklahoma visited LHDM and loved the 53 degree water at P. K. He won \$5.00 for 10 minutes without a wetsuit.

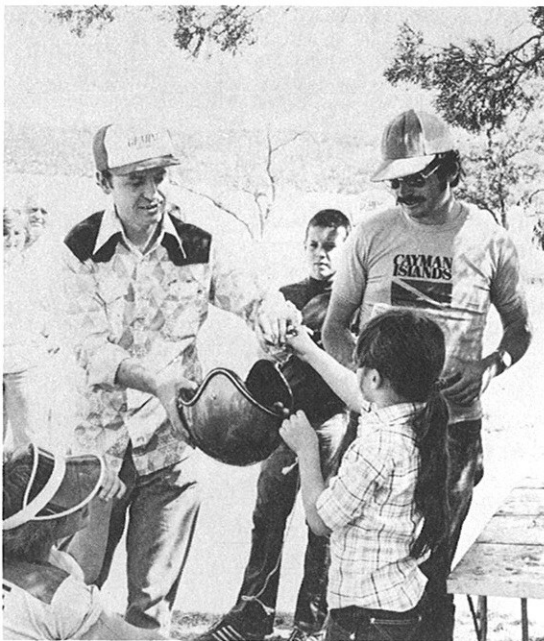

Doorprizes anyone? The helmet was won by a motorcycle rider. What luck!

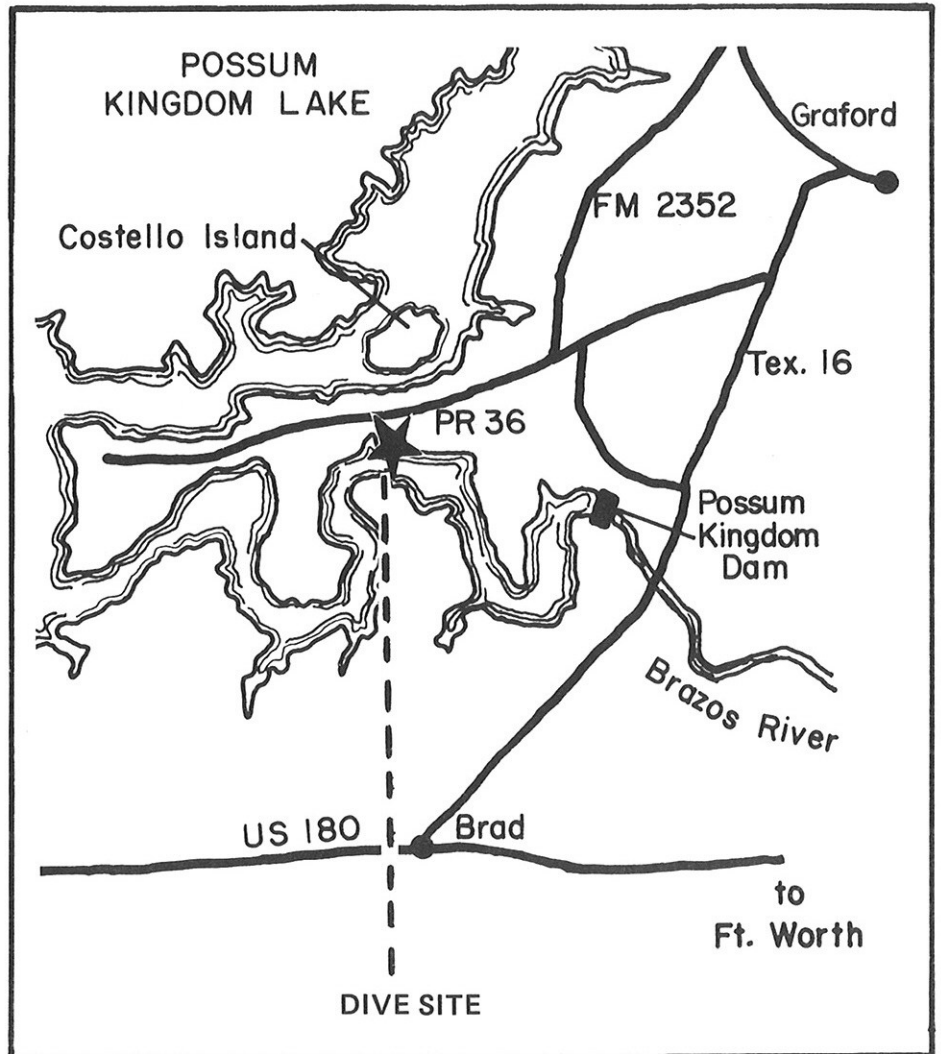

+++++ AREA 2 REPORT +++++

Area 2 would like to extend many thanks to ETA for hosting the convention. We all had a great time Saturday night at the Awards Banquet and Dance. We are proposing that the Sunday after be cancelled.

IDA's Buffalo Blast is April 7 - 8 at IDA's property. We will have a fish fry on Saturday night around 6:00 p.m. Filet of fish, hush puppies, french fries, and cole slaw. All you can eat for \$2.50 adults and \$1.25 for 10 years old and under. The scuba exchange will be at 3:00 p.m. on Saturday. Bingo will be played after the fish fry.

See you all there,

Deryle Matthews, Area 2 Vice-President



"Next week I'm trying out for the National Ballet."

A CLOSER LOOK AT THE WINNERS

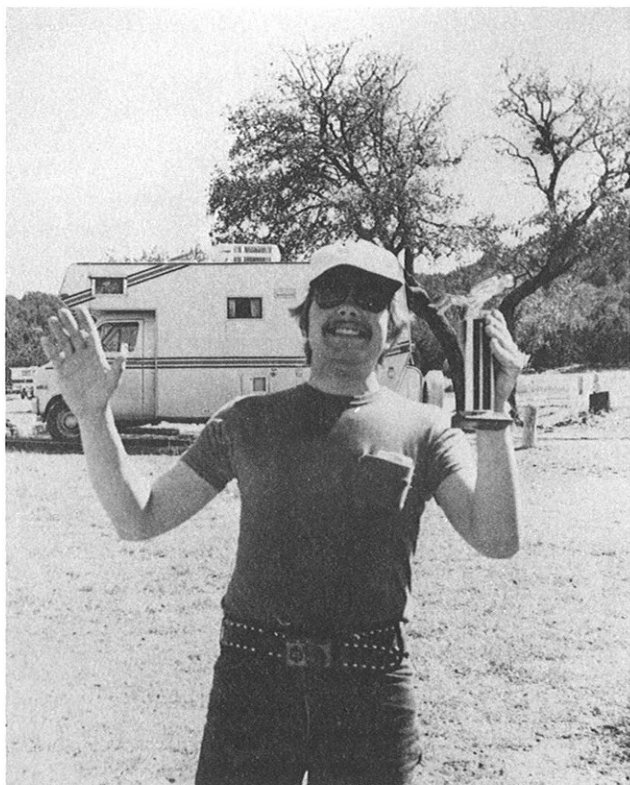

The first 1979 dive and he's a superstar!



"I really enjoy this!"

ALL NEW DACOR PACER™*

*POSITIVE AIR CONTROLLED EQUALIZING REGULATOR™

PATENTS PENDING

Highly sensitive neoprene diaphragm with bonded stainless steel plate for added wear at contact point with demand lever activator.

Stainless steel demand lever activator provides a 24 to 1 lever ratio for smooth, effortless delivery.

All brass parts are copper, nickel and chrome plated for maximum corrosion resistance.

Free turning hose swivel permits easy rotation.

Dual Exhaust System for easier exhalation and purging. (See facing page (C))

Optional extreme condition kit available.

Anti-Free Flow Device with special water chamber. (See facing page (D))

Venturamatic Flow Vane™ and Venturamatic Booster Clip™ disperse and deflect flow to "air" balance second stage. (See facing page (A), (B))

Orthodontic designed contoured mouthpiece provides maximum comfort with minimum fatigue.

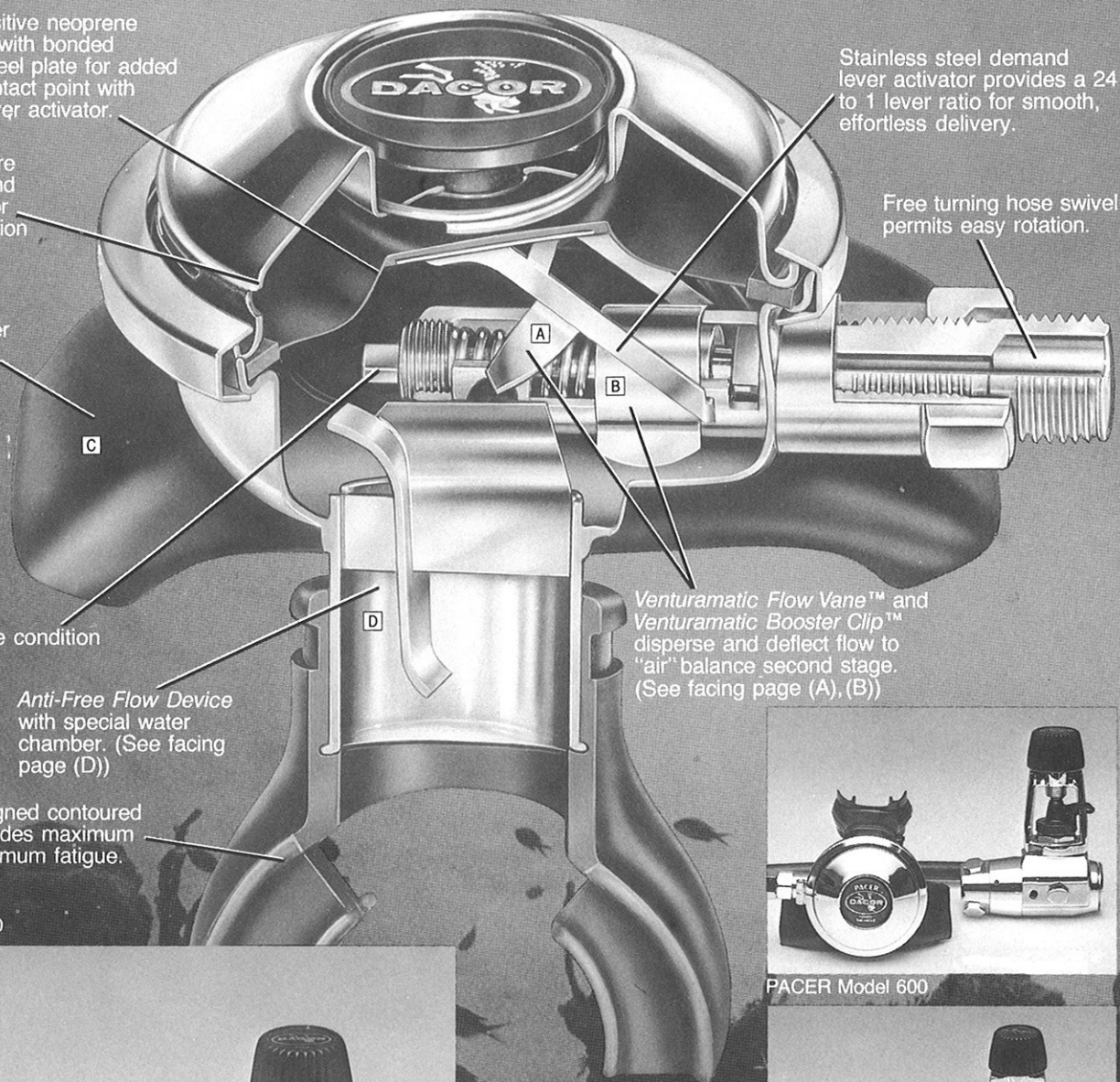

PACER Model 900

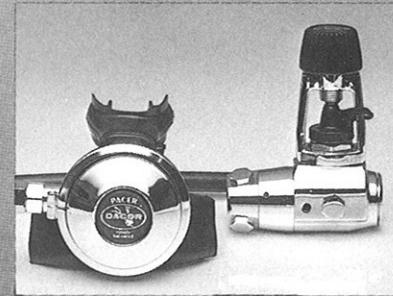
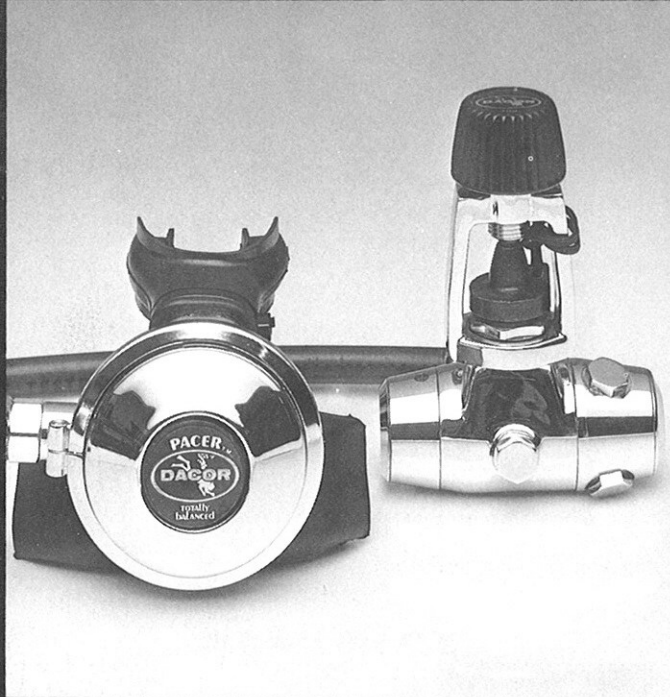

PACER Model 600

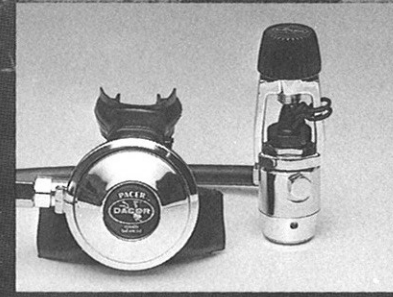

PACER Model 300

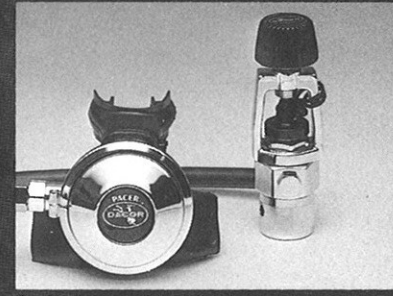

PACER Model 150

**A
WHOLE NEW
GENERATION
OF REGULATORS
THAT INCREASE
YOUR COMFORT,
CONFIDENCE,
AND
DIVE TIME.**

MAKES BREATHING BELOW AS EASY AS BREATHING ABOVE

FIRST AND SECOND STAGES ARE BOTH TOTALLY BALANCED FOR TOTAL PERFORMANCE

A DACOR FIRST—AUTOMATICALLY BALANCED SECOND STAGE FOR UNMATCHED BREATHABILITY

Dacor is proud to present a complete new line of PACER® regulators. These "Positive Air Controlled Equalizing Regulators" are not just an improvement but the most important innovation in regulator "breathability" in the 25 years we have been manufacturing diving equipment. Dacor has harnessed a principle of physics known as "Venturi" and invented a revolutionary *Venturamatic* System that completely "air balances" the PACER second stage. At the same time Dacor's *Venturamatic* System controls run-away

"Venturi" flow, surging, and free-flow—which, until now, have been a problem with all high volume regulators. The PACER's smooth laminar flow allows the diver to get the air he needs when he needs it and, at the same time, provides the same smooth, natural respiration as surface breathing at any depth and under the most extreme demand conditions. Dacor's exclusive *Dual Exhaust* feature ideally matches the PACER's large volume inhalation with the 50% easier exhalation effort.

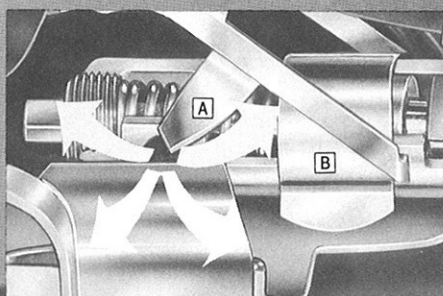

Exclusive Venturamatic™ System (PATENTS PENDING) Here's how it works—As air flow increases with lowering of valve lever, the *Venturamatic Flow Vane* (A), which is an integral part of the lever itself, also lowers and disperses the air stream in amount and direction related to volume of flow to prevent surging and uncontrolled venturi. The *Venturamatic Booster Clip* (B) effectively directs air flow to create and control venturi, making valve opening easier under high volume demand.

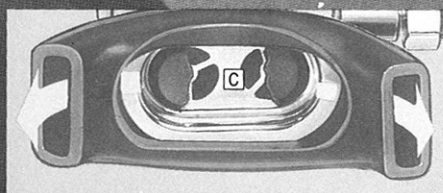

Exclusive Dual Exhaust System Here's how it works—Two large exhaust valves (C) eliminate exhalation resistance and make the PACER 50% easier in exhalation effort and purging.

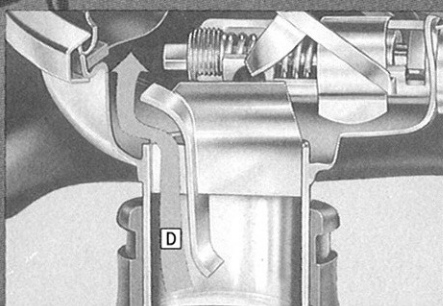

Exclusive Anti-Free Flow Device Here's how it works—When PACER is removed from the mouth underwater, water enters special chamber (D) thus balancing ambient water pressure on internal side of the diaphragm and stopping air flow. This function is automatic and takes a maximum of 3 seconds.



DACOR CORPORATION
161 Northfield Road
Northfield, Illinois 60093
P.O. Box 157

Send \$2.00 for Dacor Diver's Kit. Includes catalog, cloth patch, decomp. table, decals.

dacOR
INNOVATION IN EVERY FEATURE
of PACER'S COMPLETELY NEW FIRST STAGES

PACER FIRST STAGE FEATURE CHART

PACER MODEL NUMBER	900	600	300	150
Balanced diaphragm design	•	•	•	•
Balanced flow-thru piston design	•	•	•	•
Piston with teflon seat and back up rings for maximum sealing	•	•	•	•
Balanced first stage for minimum breathing effort and maximum air flow, regardless of tank pressure	•	•	•	•
Dual spring design provides equal pressure on high pressure diaphragm for smoother first stage opening	•	•	•	•
Swivel attachment yoke for proper alignment of low and high pressure hoses	•	•	•	•
3 low pressure ports on swivel for comfortable alignment of hoses for vest, dry suit or octopus	•	•	•	•
2 high pressure ports, one on each side of first stage allows use of underwater pressure gauge on either side	•	•	•	•
Heavy forged naval brass body, triple chrome plated	•	•	•	•
Heavy brass triple chrome plated body, yoke and yoke screw	•	•	•	•
Optional European din yoke for overseas use	•	•	•	•
Optional silicone hydraulic protection system	•	•	•	•

TROPHIES AWARDED AT THE LHDM DIVE
March 18, 1979

SPEARFISHING

Men's Division

MOST FISH	No. of Fish	Club
1st James Permenter	7	IDA
LARGEST FISH	Agg. Wt.	Club
1st Ben Sleigh	8 lbs., 15 oz.	LHDM
2nd John Fuller	8 lbs., 9 oz.	LHDM
3rd Bill Roden	8 lbs., 4 oz.	ETA
TEAMS	Total Agg. Wt.	Club
1st Permenter & Hubenak	49 lbs., 0 oz.	IDA
2nd Sleigh & Fuller	41 lbs., 13 oz.	LHDM
3rd Cole & Pepper	21 lbs., 10 oz.	ETA

Novice Division

MOST FISH	No. of Fish	Club
1st Baty Houston	1	LHDM
2nd Richard Opperman	1	ETA

LARGEST FISH	Agg. Wt.	Club
1st Baty Houston	5 lbs., 12 oz.	LHDM

Ladies Division
None

SCUBA SKILLS - COMPASS RUN

	Club
1st Forrest Garland	ETA
2nd Carl Garrison	LHDM
3rd Ben Sleigh	LHDM
4th Susan Stewart	Texins



SCUBA SKILLS WINNERS: (l to r) Carl Garrison (2nd); Susan Stewart (4th); Ben Sleigh (3rd); Forrest Garland (1st)



SPEARFISHING WINNERS: (standing l to r) Carl Garrison (by mistake 3rd team); Richard Opperman (2nd most fish, novice division); James Permenter (1st most fish); Gordon Hubenak (1st team); Jim Wooldridge (by mistake 3rd team); Baty Houston (1st most fish, novice division); (in front l to r) John Fuller (2nd largest fish and 2nd team); Ben Sleigh (1st largest fish and 2nd team); Bill Roden (3rd largest fish) (should have been pictured as 3rd team) Clyde Cole and Kenneth Pepper

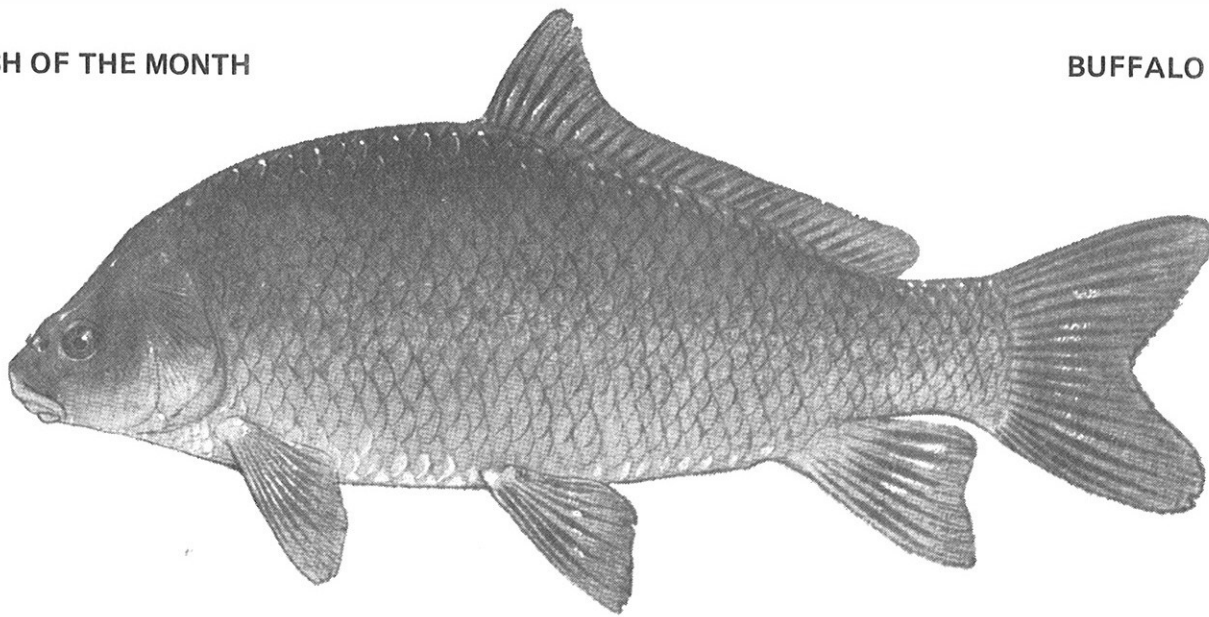

Smallmouth buffalo

With the IDA Buffalo Blast coming up, here is some information about the buffalo. SWC member Wade Garvin of the East Texas Aquanauts holds the national record for buffalo speared. He got the 30 lb., 4 oz. fish and earned an Underwater Society trophy at the AA Aquajets dive last year. (See picture)

Distribution in Texas: Buffalo may be found in every river system in the state and in almost (but not quite) all major lakes and streams.

Description: The buffalo is a member of the sucker family and has a sucker-type mouth. The body of the fish is deep and slightly compressed and has a large head. The color varies from very light gray to dark gray to almost black. Scales are very large. Buffalo reach large sizes, with 30 pounds not uncommon. Large buffalo are easily separated from large carp by the novice angler [spearfisherman!], since all carp have barbels ("feelers" or "whiskers") around the mouth and no buffalo do.

Life History: Buffalo spawn in the spring at water temperatures of 60 to 65 degrees. Spawning takes place randomly over weed beds or mud bottoms. Eggs hatch in seven to 14 days. It takes about three years for fish to reach maturity. Food consists primarily of plankton, insect larvae and vegetation.

Additional Information: In some areas, buffalo are highly prized by anglers because of their sporting abilities. The flesh is of exceptional flavor and is

a favorite of many in spite of the numerous bones. Buffalo in Texas lakes make up over 90 percent of the catch of commercial fishermen who annually net and sell over a million pounds.

Species: There are three species of buffalo in Texas, the smallmouth buffalo, the black buffalo and the bigmouth buffalo. The above information pertains to all three species although the smallmouth buffalo is the most common. The black buffalo is the darkest of the species. The bigmouth buffalo is slaty-blue and lives in clear water.

Source: Texas Parks and Wildlife Department



1979 ANNUAL CONVENTION MINUTES

The SWC held its annual convention in Longview, Texas February 2 - 3, 1979. Listed below are the highlights of the minutes of that meeting.

NEW PHOTOGRAPHY CONTEST

The Council passed the proposal made by John Lee of the Dallas Divers to host a New Concept Photography Contest. The contest will be one in which each contestant registers an unexposed roll of film with a contest committee at the beginning of the dive, takes pictures of a specified subject, and turns in the film at a designated time. The film will be developed, judged, and trophies awarded.

UNDERWATER SOCIETY DUES

The Council voted to have SWC dues be \$10.00 per person and to include payment of Underwater Society dues for each member, making the SWC 100 percent Underwater Society.

SAFETY PROPOSALS

To promote safety at SWC Sanctioned Dives, the Council voted to have a sign-in list at the weigh-in line. If someone has not signed-in by 30 minutes past the weigh-in time, he will be assumed to be lost or broken-down and a search will be made. Persons who are not lost or broken-down neglecting to sign-in will lose entry points for the contest. Non-SWC members will be disqualified from diving at SWC sponsored dives for a year.

Also, the Council voted that the host club of a SWC Sanctioned Dive will have a safety boat available to search for any diver not in by the established time.

1979 SCUBA NATIONALS

The Council passed a proposal to submit a bid to host the 1979 Scuba Nationals competition.

CANCELED DIVES

The Council voted that in the event of a cancellation by the host club of one of the eight scheduled dives, the canceled dive can be picked up by another club and held at the same location on the same date.

ATTENDANCE PATCHES FOR NON-DIVERS

The proposal was passed to allow non-divers seeking to earn 100 percent attendance patches awarded at the annual convention to pay \$1.50 to the SWC to earn credit for their attendance.



415 WALTER
LONGVIEW, TEXAS 75603

100% SOUTHWEST
COUNCIL MEMBERSHIP



1979 SCHEDULE OF EVENTS

March 17 & 18	Sanctioned Dive	Possum Kingdom	Les Hommes de Mer
April 7 & 8	Buffalo Blast	Possum Kingdom	Inland Divers Association
May 12 & 13	Underwater Safari	Lake Travis	Texins
June 2 & 3	Carp Shootout	Lake Whitney (TBA)	AA Aquajets
July 21 & 22	Sanctioned Dive	Lake Ouachita	Blue Ridge Divers
September 29 & 30	Catfish Roundup	TBA	Lawton Divers
December 8 & 9	Gar Rodeo	Caddo Lake	East Texas Aquanauts

1979 SOUTHWEST COUNCIL OFFICERS

Robert Swilley, President
Bos 308
Waskom, Texas 75692
214/687-2727

Ed Ralston, Underwater Society Rep.
3401 N. Meridian Ct.
Oklahoma City, Oklahoma 73122
405/942-0252

Deryle Matthews, Area 2 Vice President
116 Charlene
Hurst, Texas 76053
817/282-3082

Bill Roden, Executive Vice-Pres.
Rt. 2 Box 322H
Longview, Texas 75605
214/663-1231

Charlie Wright, Public Relations
702 S. W. 52nd St.
Lawton, Oklahoma 73505
405/248-0679

Jack Echart, Area 3 Vice-President
2204 Ridgeway St.
Arlington, Texas 76010
817/261-4390

Elizabeth Saunders, Secretary
P. O. Box 889
Longview, Texas 75601
214/753-0178

Dave McMurray, Director
2525 Santa Cruz
Dallas, Texas 75227
214/381-3045

Bart McCollum, Area 4 Vice-President
3325 Providence
Midland, Texas 79701
915/694-8948

Myrna Jorgensen, Treasurer
2805 Great Valley
Leander, Texas 78641
512/258-6494

Glen Sheridan, Director
1904 Anna
Irving, Texas 75061
214/438-5737

Ron Jorgensen, Area 5 Vice-President
2805 Great Valley
Leander, Texas 78641
512/258-6494

Helen Holcomb, Slate Editor
5919 Birchbrook Apt. 133
Dallas, Texas 75206
214/692-7714

Susan Stewart, Area 1 Vice-President
1631 Aurora
Richardson, Texas 75081
214/231-7739

Clyde Cole, Area 6 Vice-President
415 Walter
Longview, Texas 75603
214/643-2710

Roy McWright, Area 7 Vice-President
2302 Nottingham Rd.
Lawton, Oklahoma 73505
405/355-8196



SOUTHWEST COUNCIL OF DIVING CLUBS



MEMBERSHIP INTO THE COUNCIL

Send the following to:
Robert Swilley, Box 308, Waskom, Texas 75692
Phone: 214/687-2727

1. Copy of the club's constitution and/or by-laws.
2. Membership list of the club including names, addresses, and designated officers.
3. Membership fee (\$20.00 for the club and \$10.00 per individual).

Membership in the Council is from January 1st through December 31st, at which time dues become due. However, there is a grace period of three months, January 1st through March 31st, at which time dues expire. Dues may be paid in December of the previous year for the ensuing year if the membership is not used for any Council activity before January 1st.

UNDERWATER SOCIETY OF AMERICA

Council membership fees include membership in the Underwater Society of America, the nationwide organization representing divers. USA membership provides a subscription to the "Underwater Reporter", insurance coverage, input into legislation affecting divers and/or ecological interests, and participation in organized activities and awards.

INFORMATION ABOUT THE COUNCIL

Anyone wishing information about the Council, its activities, etc., should send inquiries to the President or any officer in your general area. Refer to the inside for a list of officers, mailing addresses, and phone numbers.

SUBSCRIBE TO THE "SLATE"

Subscription is free to members of the Council. Rates to non-members are 35 cents per copy or \$3.50 per year. Mail subscriptions to Helen Holcomb, 5919 Birchbrook Apt. 133, Dallas, Texas 75206. Make checks payable to the Southwest Council.

NEWSLETTER

The "Slate" is the voice of the Southwest Council of Diving Clubs and is published monthly. Articles in the "Slate" may be reproduced in full (unless otherwise specified) as long as credit is given to the "Slate" and authors of the articles.

NOTICE

Articles and pictures for publication in the "Slate" must be in by the 10th of each month as the publication date will be the 15th of each month. Send all material to: "Slate", 5919 Birchbrook Apt. 133, Dallas, Texas 75206.



SLATE

5919 Birchbrook Apt. 133
Dallas, Texas 75206

NONPR. ORG.
U. S. Postage
PAID
Dallas, TX
Permit No. 993

Bart A. McCollum
3325 Providence
Midland, Tx 79703